

The illustrations, technical information, data and descriptions contained in this publication, were correct at the time of going to print. We reserve the right to make any changes necessary in line with continuous development and improvement.

This publication may not be duplicated, reprinted, stored in a data processing system or transmitted by electronic, mechanical, photographic or other means, or recorded, translated, edited, abridged or expanded without the prior written consent of Ford-Werke GmbH. The same also applies for parts of this manual and their use in other publications.

Although due care has been taken to make this publication as complete and accurate as possible, it can still be subject to alterations.

This publication describes options and trim levels available throughout the Ford model range in every European country, and therefore some of the items covered may not apply to your vehicle.

**Important:** Ford genuine parts and accessories have been specifically designed for Ford vehicles. They are dedicated for your Ford vehicle.

We would like to point out that other parts and accessories than mentioned above have not been examined and approved by Ford unless explicitly stated by Ford. In spite of continuous market product monitoring, we cannot certify the suitability of such products. Ford is not liable for any damage caused by the use of such products.

© Copyright 2005

Issued by Ford-Werke GmbH, Ford Customer Service Division

Code No CG3441en LHD 07/2005

## Contents

<b>Quick start</b>	<b>2</b>
<b>Introduction</b>	<b>12</b>
<b>Instrumentation</b>	<b>14</b>
<b>Vehicle information systems</b>	<b>22</b>
<b>Climate controls</b>	<b>36</b>
<b>Lights</b>	<b>46</b>
<b>Driver controls</b>	<b>54</b>
<b>Locks (security)</b>	<b>64</b>
<b>Seating and safety restraints</b>	<b>77</b>
<b>Driving</b>	<b>98</b>
<b>Roadside emergencies</b>	<b>138</b>
<b>Cleaning</b>	<b>161</b>
<b>Maintenance</b>	<b>163</b>
<b>Capacities and specifications</b>	<b>172</b>
<b>Index</b>	<b>184</b>

# Quick start

## STORAGE AREAS

### Front storage compartment

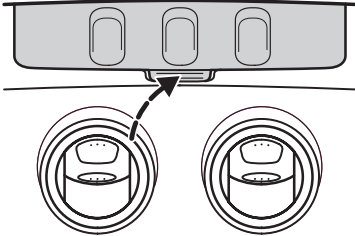

- Press the button to open.
- To close, push the cover down until it engages.

**Note:** Avoid keeping heat-sensitive objects in the front storage compartment.



Never drive with the front storage compartment lid open. This will obscure your vision out of the front screen. Before setting off, always ensure that the lid is securely engaged.

### Storage compartment

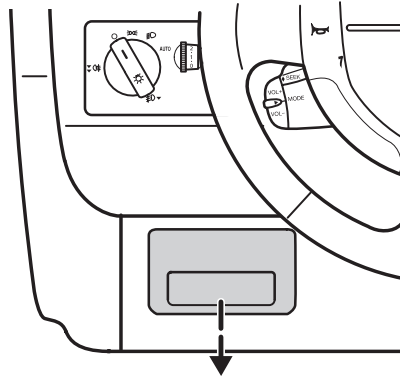

A storage compartment is provided underneath the instrument panel on the drivers side.

### Glove compartment

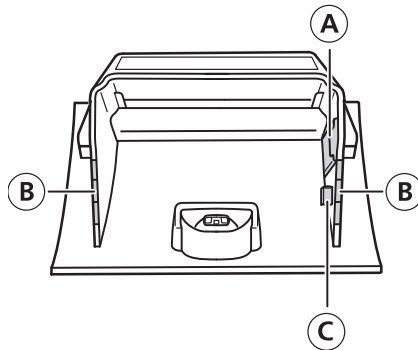

- (A) Card holder
- (B) Coin holders
- (C) Pen/pencil clip

## Quick start

### Under-seat storage

The storage box is located under the front passenger seat.

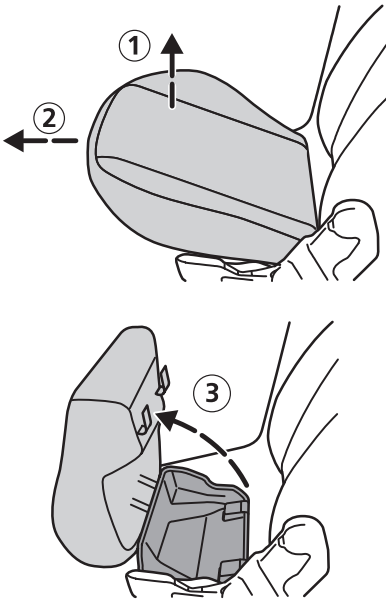

- To open: Pull the front of the seat cushion up ①.
- Pull the seat cushion towards the instrument panel ②.
- Lift the seat cushion to reveal the storage area ③.
- To close, follow the above steps in reverse, making sure that you push the seat cushion downwards until it locks into place.

### Storage pockets

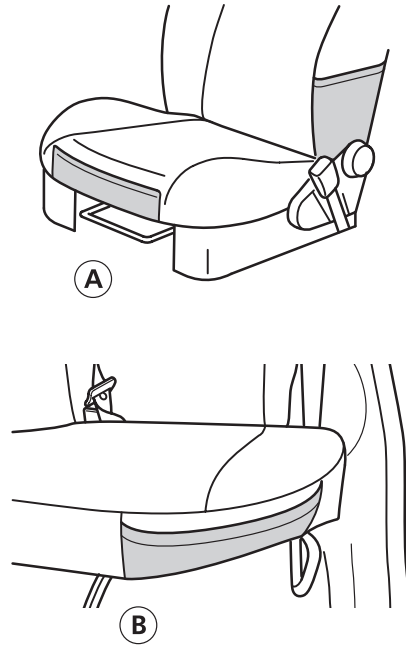

- Ⓐ Driver's seat
- Ⓑ Rear seats

## Quick start

### Map pockets (front seats)

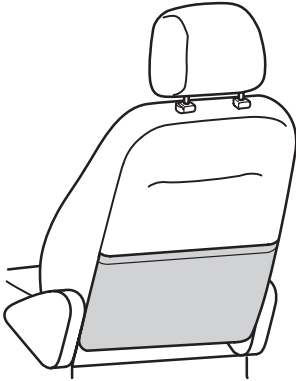

### FOLDING THE REAR SEAT CUSHION AND SEATBACK FORWARDS

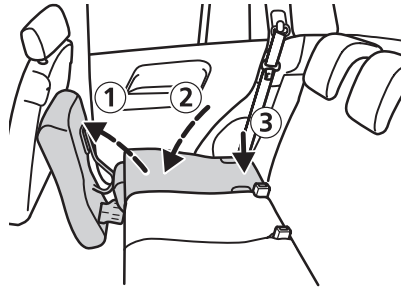

- Slide the front seat forwards.
- Fold the seat cushion forwards ①.
- Lower the head restraints. Pull the locking handle on the rear seatback and fold the seatback forwards ②.
- Press the rear of the seatback down to create a level surface ③.
- When returning the seats to their original positions, make sure the seat belts will function properly and are positioned in front of the seatback.

## Quick start

### MULTIFUNCTION DISPLAY

For details, refer to page 20 onwards.

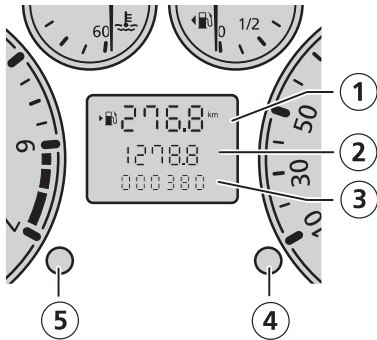

- ① Distance to empty or digital clock

To toggle between distance to empty and the clock, briefly press the right-hand button ④ on the instrument cluster.

Depending on the audio system fitted, the clock is displayed only while the right-hand button ④ is pressed. Displaying the clock permanently and the setting of the clock is available on the audio system only.

- ② Tripmeter

To reset, press and hold the left-hand button ⑤ on the instrument cluster.

- ③ Odometer

### MESSAGE CENTRE

For details, refer to page 20 onwards and page 22 onwards.

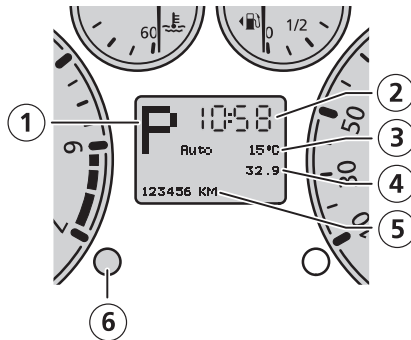

The display shows:

- ① Gear display  
(vehicles with automatic transmission or Durashift EST)
- ② Clock or the audio system display  
(depending on the audio system equipped, if the audio system is switched on or off and the individual Message Centre settings)
- ③ Outside air temperature
- ④ Tripmeter
- ⑤ Odometer
- ⑥ Display warning light

The warning light accompanies the warning and info messages and illuminates red or amber.

## Quick start

### Functions of the main menu

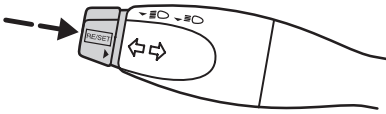

Press the **RE/SET** button briefly to scroll through the following menu functions:

- Distance to empty
- Average speed
- Average fuel
- Fuel economy (depending on country)
- Time setting (when the vehicle is stationary and depending on audio system fitted)
- Individual settings (when the vehicle is stationary)
- Warning and info messages

Press and hold the **RE/SET** button to change or reset the desired function or to enter the settings menus.

### Personalised settings

The following personalised settings are available on the Message Centre:

- Remote unlocking

The vehicle can be set to unlock only the driver's door or to unlock all doors when the  button is pressed once.

- Lane change indicators

The direction indicators can be set to flash three times when the multifunction lever is tapped up or down.

- Radio display

The Message Centre can display some audio system information.

- Hazards on heavy braking

The hazard light can be set to flash automatically if the brakes are applied abruptly (e.g. emergency braking).

- Chimes

Some of the convenience chimes can be deactivated.

- Language menu

Different languages can be chosen to be used for the display.

## Quick start

### CLIMATE CONTROLS

For details, refer to chapter *Climate controls*, page 36 onwards.

### Screen defrosting/demisting

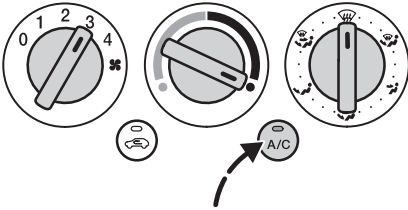

Set the blower to position **3** or **4**, select the maximum temperature and set the air distribution control to . Switch on the air conditioning (if equipped) to support demisting.

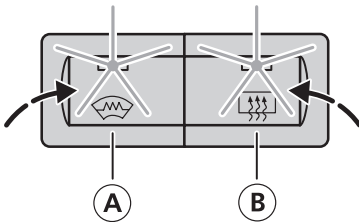

If necessary, switch on

- A** the heated front screen and
- B** the heated rear screen.

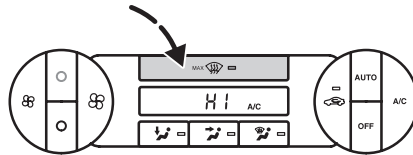

On vehicles with Electronic Automatic Climate Control press the button. This will activate the heated screens as well as selecting the maximum temperature and blower speed.

If the button is pressed again, the system returns to the previous setting. The heated screens switch off automatically after a short time.



## Quick start

### Rapid cooling of the vehicle interior

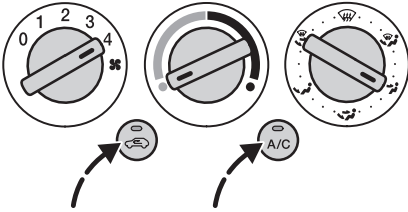

Set the blower to position **4**, select the minimum temperature and set the air distribution control to . Switch on the air conditioning and recirculated air.

If the windows start to mist up after rapid cooling, switch off the recirculated air.

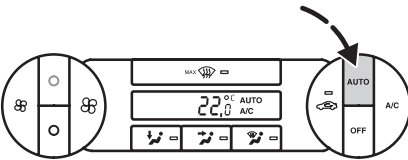

On vehicles with Electronic Automatic Climate Control press the **AUTO** button. The Electronic Automatic Climate Control adjusts to the current circumstances automatically.

### LOCKS (SECURITY)

For details, refer to chapter *Locks (security)*, page 64 onwards.

### Locking/unlocking the vehicle

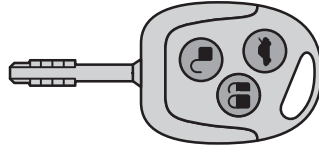

- Press **once** to activate central locking and arm the anti-theft alarm system (if equipped)
- Press **twice** within three seconds to activate double locking and arm the anti-theft alarm system (if equipped)
- Press once to unlock the vehicle. For personal settings, refer to section *Reprogramming the unlocking function*, page 70.
- Press **twice** within three seconds to unlock/open the tailgate only.

**Note:** The doors cannot be opened from inside the vehicle when double locking is activated.

### AUDIO SYSTEMS

For details, refer to the separate manual.

#### Automatic volume control (AVC)

This function increases or decreases the volume of the audio system relative to the vehicle speed. For personal settings, refer to the separate manual.

#### Setting the time and date

To enter the settings mode press the **CLOCK** button on the audio system.

Press the ◀ or ▶ button to toggle between time and date.

To set the time/date turn the rotary control.

Press the **CLOCK** button to save the setting and exit the settings mode.

### DIESEL LOW FUEL SAFETY MODE

Diesel engines must never run out of fuel. They have safety devices to prevent this. They will reduce engine power by up to 30 % when a low fuel level is detected, as indicated by the low fuel warning light.

The system will also shut down (i.e. the engine will stop completely) just prior to reaching zero fuel to prevent re-starting problems and, more importantly, severe engine damage.

To start the engine, see the section *Diesel low fuel safety mode* on page 124.

#### Benefits of the diesel low fuel safety mode

This mode maximises fuel efficiency under very low fuel conditions and helps to prevent:

- Running out of fuel too quickly
- Clogging the fuel system
- Placing excess pressure on the engine, that would result in costly and severe engine damage

# Quick start

## ELECTRICAL FEATURES

### Autolamps

For details, refer to page 46 onwards.

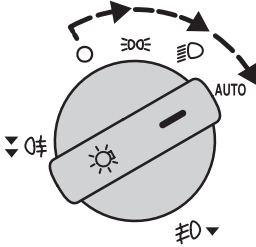

When the exterior light switch is set to position **AUTO**, the dipped beam headlights will switch on and off automatically depending on the ambient light. The Autolamps are activated only when the ignition is switched on (position II).

### Home safe light

For details, refer to page 48.

With the ignition switched off the headlights can be switched on and will be switched off automatically after a period of time.

On vehicles **with** Autolamps:

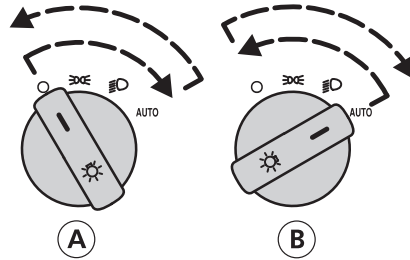

- (A) turn the exterior lights switch from the position  $\circ$  to position **AUTO** and back to position  $\circ$  within 2 seconds, **or**
- (B) turn the exterior lights switch from the position **AUTO** to position  $\circ$  and back to position **AUTO** within 2 seconds.

On vehicles **without** Autolamps:

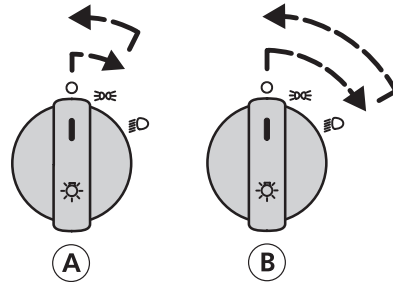

- (A) turn the exterior lights switch from the position  $\circ$  to position  $\text{☀}$  and back to position  $\circ$  within 2 seconds, **or**
- (B) turn the exterior lights switch from the position  $\circ$  to position  $\text{☀}$  and back to position  $\circ$  within 2 seconds.

## Quick start

### Welcome lights

For details, refer to page 49.

The side and tail lights will switch on automatically for 25 seconds when the door is unlocked using the remote control. Once all doors are closed, the welcome lights will switch off automatically after 5 seconds or at once if the ignition is switched on.

### Autowipers/intermittent wiping

For details, refer to page 55 onwards.

Depending on the model variant, auto wipers or intermittent wiping are selected by moving the wiper lever one position upwards.

When the ignition is switched on with the wiper lever in the Autowipers position, the wipers will not cycle until water is detected on the front screen.

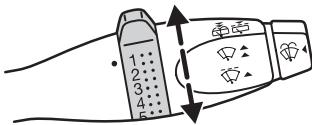

Select the wipe interval or the rain sensor sensitivity of the auto wipers with the rotary switch:

- 1** = Short time interval/  
high sensitivity
- 6** = Extended time interval/  
low sensitivity

### Power folding mirrors

For details, refer to page 60.

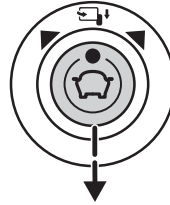

With the interior switch in the centre position, push the control unit down to fold the mirror. To return the door mirror to its original position push the control unit down again.

Press the  button once to lock the vehicle: the door mirrors will fold automatically if they are not already folded back using the control unit.

Press the  button once to unlock the vehicle: the door mirrors will unfold automatically if they were automatically folded back.

# Introduction

## PREFACE

Congratulations on acquiring your new Ford. Please take the time to get well acquainted with your vehicle by reading your owner literature. The more you know and understand about your vehicle the greater the safety, economy, and pleasure you will derive from driving it.

The Owner's Handbook describes every option and model variant available in every European country and therefore some of the items covered may not apply to your particular vehicle. Furthermore, due to printing cycles it may describe options before they are generally available.

Regular servicing of your vehicle helps maintain both its road-worthiness and its resale value. A network of more than 7 000 Ford authorized repairers throughout Europe can help you with their professional servicing expertise.

Their specially trained personnel are best qualified to service your vehicle properly and expertly. Also, they are supported by a wide range of highly specialised tools and equipment specially developed for servicing Ford vehicles.



Remember to pass on the Owner's Handbook when reselling the vehicle. It is an integral part of the vehicle.

### FOR YOUR SAFETY AND ENVIRONMENTAL PROTECTION



#### Warning symbols in this handbook

How can you reduce the risk of personal injury and prevent possible damage to others, your vehicle and its equipment? In this handbook, answers to such questions are contained in comments highlighted by the warning triangle symbol.

**Note:** Important information is also given in paragraphs starting with the highlighted word **Note**.



#### Warning symbols on your vehicle



When you see this symbol, it is imperative that you consult the relevant section of this

handbook before touching or attempting adjustment of any kind.

### RUNNING IN

Avoid driving too briskly during the first 1 500 km. Vary the speed frequently and change up a gear early. Avoid labouring the engine.

New tyres require a running-in distance of approximately 500 km. During this period, the car may exhibit different driving characteristics. Therefore, avoid driving too briskly during the first 500 km.

If possible, you should avoid heavy use of the brakes for the first 150 km in town and for the first 1 500 km on motorways.

From 1 500 km onwards you can gradually increase the performance of your vehicle up to the permitted maximum speeds.

We wish you safe and pleasurable driving with your Ford vehicle.

# Instrumentation

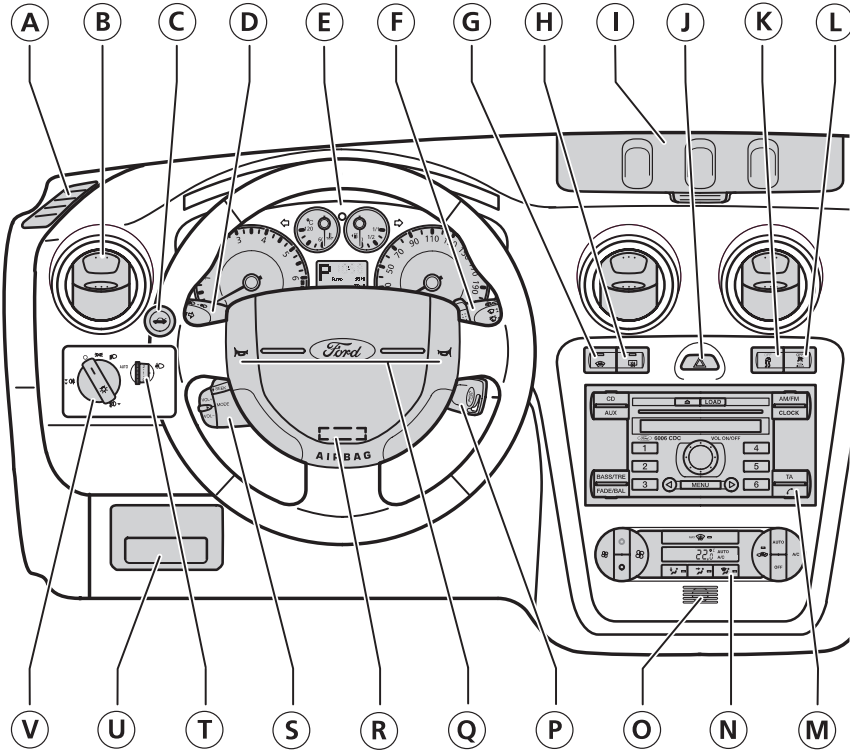

Position	Description	See page
(A)	Side window demister	36
(B)	Ventilation vents	36
(C)	Luggage compartment release	66
(D)	Multifunction lever: direction indicators, main beam, message centre	51-52, 22

## Instrumentation

Position	Description	See page
Ⓔ	Instrument cluster	16-21
Ⓕ	Wiper lever	55-57
Ⓖ	Heated front screen switch	45
Ⓗ	Heated rear screen switch	45
Ⓘ	Front storage compartment	128
Ⓙ	Hazard flasher switch	138
Ⓚ	Electronic Stability Program (ESP) <sup>1</sup>	101-102
	Coin holder <sup>1</sup>	130
Ⓛ	Airbag deactivation light <sup>1</sup>	91-92
	Coin holder <sup>1</sup>	130
Ⓜ	Audio systems/navigation system: see the separate manual	–
Ⓝ	Heating/ventilation/air conditioning	36-45
Ⓞ	Interior temperature sensor <sup>2</sup>	42
Ⓟ	Ignition switch	102
Ⓠ	Horn	54
Ⓡ	Steering wheel adjustment	54
Ⓢ	Audio remote control	58
Ⓣ	Headlight levelling control	50
Ⓤ	Storage compartment	128
Ⓥ	Exterior lights/front fog lights/ rear fog lights	46-50

<sup>1</sup> Depending on model variant.

<sup>2</sup> Vehicles with Electronic Automatic Climate Control.





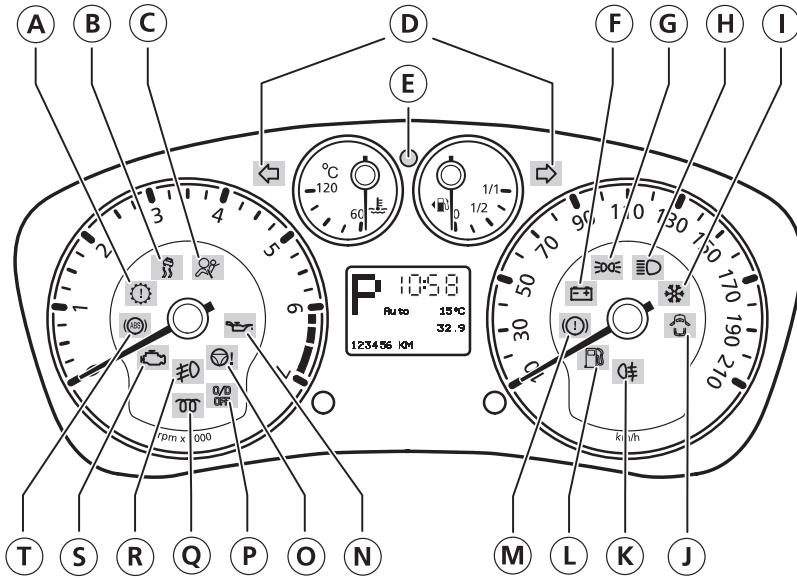











# Instrumentation



## WARNING AND INDICATOR LIGHTS IN THE INSTRUMENT CLUSTER

Position	Symbol	Function	See page
A		Transmission/Engine systems fault warning light	113 <sup>1</sup> , 122
B		ESP indicator light	101-102
C		Airbag/seat belt pretensioner warning light	91
D		Direction indicator light	52
E		Engine immobilisation system indicator light	73

## Instrumentation

Position	Symbol	Function	See page
F		Ignition warning light	156
G		Headlight indicator light	47
H		Main beam indicator light	52
I		Frost warning light	124
J		Doors open warning light <sup>2</sup>	67
K		Rear fog light indicator light	48
L		Low fuel level warning light	124
M		Brake system warning light	98, 99, 168
N		Oil pressure warning light	168
O		Power assisted steering warning light <sup>3</sup>	123
P		Overdrive indicator light <sup>1</sup>	109
Q		Glow plug indicator light	104
R		Front fog light indicator light	47-48
S		Engine warning light	123
T		ABS warning light	99

<sup>1</sup> Vehicles with automatic transmission.

<sup>2</sup> Depending on model variant.

<sup>3</sup> Vehicles with 1.6 l Duratorq-TDCi engine.

## Instrumentation

The following warning and indicator lights illuminate when the ignition is switched on:

- ABS  
(depending on model variant)
- Airbag/seat belt pretensioner
- Brake system
- Doors open  
(depending on model variant)
- Engine
- Engine immobilisation
- ESP  
(depending on model variant)
- Frost
- Ignition
- Oil pressure
- Power assisted steering  
(vehicles with 1.6 l Duratorq-TDCi engine)
- Transmission/engine systems

If a warning or indicator light does not illuminate when the ignition is switched on, it indicates a malfunction. Have the system checked by an expert.

## Instrumentation

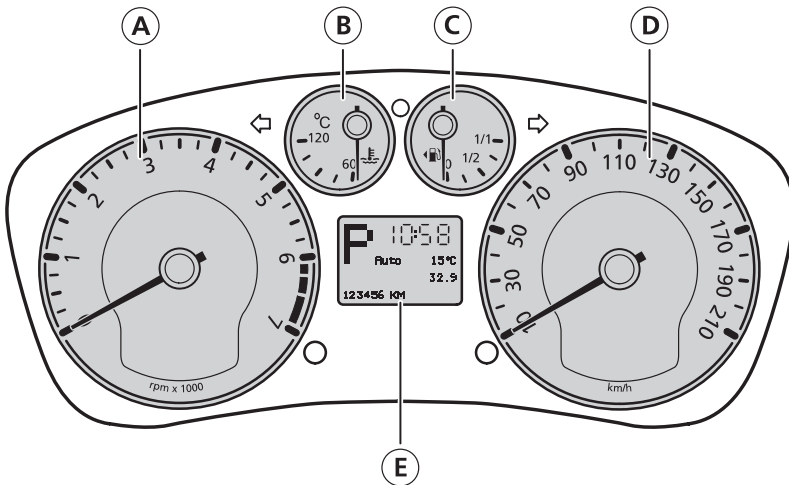

### GAUGES

#### Ⓐ Tachometer

On vehicles with a diesel engine, the tachometer goes to 6 000 revolutions per minute.

#### Ⓑ Engine coolant temperature gauge

At normal operating temperature, the temperature indicator remains within the centre section.

If the needle enters the red section and/or the Engine coolant temperature warning appears, the engine is overheating.

Switch off the ignition and determine the source of the problem once the engine has cooled down.

Refer also to section *Cooling system reservoir*, page 169.

#### Ⓒ Fuel gauge

The arrow adjacent to the fuel pump symbol indicates on which side of the vehicle the fuel filler cap is located.

#### Ⓓ Speedometer

# Instrumentation

## Ⓔ Multifunction display or Message Centre

Depending on the model variant, the vehicle is equipped with a multifunction display or a display for the Message Centre.

The display is activated when the driver's door is opened or the ignition is switched on.

With the ignition switched off (position **0**) and the key removed, the display will be automatically deactivated after approximately 10 minutes.

### **Multifunction display** (depending on vehicle variant)

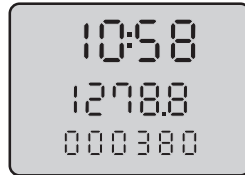

## ① **Distance to empty and digital clock**

Press the right-hand button **④** on the instrument cluster briefly to toggle between the displays.

## • **Distance to empty**

Indicates the approximate distance the vehicle will travel on the fuel remaining in the tank. Changes in driving pattern may cause the value to vary.

## • **Digital clock**

**Note:** Depending on the audio system fitted, the clock is displayed only while the right-hand button **④** is pressed. Displaying the clock permanently and the setting of the clock is available on the audio system only. Please see chapter *Quick start*, page 9, or the separate manual.

The setting of the clock is only possible when the vehicle is stationary.

## Instrumentation

To set the time:

- Turn the ignition key to position **II**.
- Press and hold the right-hand button **④** until the time display flashes.
- To advance the time, press the right-hand button **④** briefly. Each press advances the time by one minute.

To advance rapidly, hold the button **④** pressed.

### **② Tripmeter**

The tripmeter can register the mileage of individual journeys.

To reset, press and hold the left-hand button **⑤** beneath the display.

**Note:** If **Sh on** appears in the display instead of the tripmeter, the shipping mode of the vehicle's electric system is activated. Please contact your dealer to deactivate this mode.

### **③ Odometer**

Registers the total mileage of the vehicle.

### **Message Centre**

(depending on model variant)



### **① Gear display**

For information, refer to the section *Gear display*, page 107 (vehicles with automatic transmission) or page 116 (vehicles with Durashift EST).

### **② Clock or the display of the audio system**

### **③ Outside air temperature**

### **④ Tripmeter**

### **⑤ Odometer**

### **⑥ Display warning light**

For further information about the Message Centre, refer to the chapter *Vehicle information systems*, page 22 onwards.

## Vehicle information systems

### MESSAGE CENTRE

Switch on the ignition (position **II**) to activate the Message Centre.

Various systems can be programmed using the Message Centre and the multifunction lever on the steering column.

The Message Centre also provides warning messages about faults or system malfunctions. For further details, refer to the section *Warning/information messages*, page 26.



For road safety reasons, set and reset the functions only when the vehicle is stationary.

**Note:** The displays depend on the equipment fitted and therefore certain displays may not appear in the Message Centre of your particular vehicle.

The display is activated when the driver's door is opened or the ignition is switched on.

With the ignition switched off (position **0**) and the key removed, the display will be automatically deactivated after approximately 10 minutes.

**Note:** If **SHIP ON** appears in the display, the shipping mode of the vehicle's electric system is activated. Please contact your dealer to deactivate this mode.

### Controls

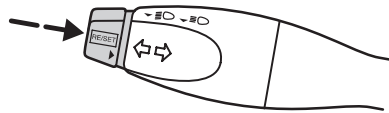

Press the **RE/SET** button briefly to toggle between the displays.

Press and hold the **RE/SET** button to reset, to choose a submenu, or to adjust the settings.

If all chimes are activated, a short tone will sound to confirm a reset or a selection.

## Vehicle information systems

Menu	Display/sub-menu	See page
Main menu	Overview	24
	Outside air temperature	25
	Odometer/Tripmeter	25
	Distance to empty	25
	Average speed	25
	Average fuel consumption	25
	Fuel economy	25
	Warning/information messages	26
	Time setting	30
Settings menu	Overview	31
	Remote unlock mode	33
	Lane change indicators	33
	Radio display	33
	Hazards on heavy braking	33
	Chime deactivation	34
	Language setting	34
	Measure units	35
	Settings - exit	35



# Vehicle information systems

## Main menu

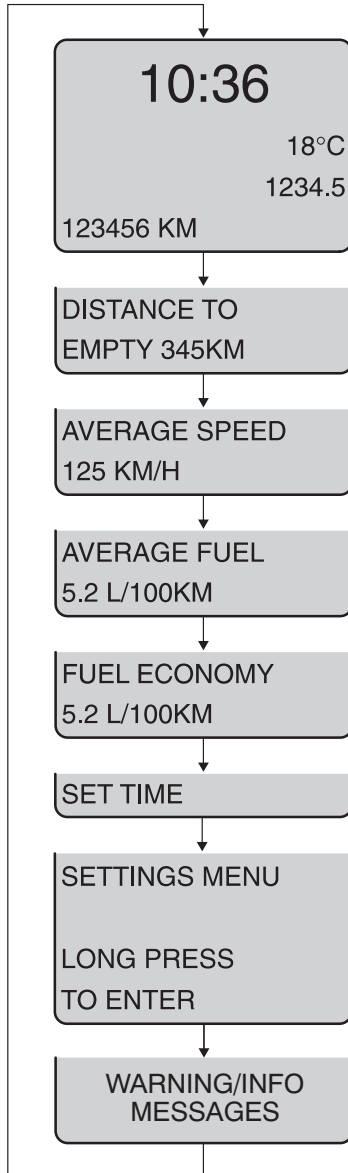

## Vehicle information systems

Press the **RE/SET** button briefly to toggle between the displays.

Press and hold the **RE/SET** button to reset or to choose a sub-menu.

### **Outside air temperature**



18°C

Shows the outside air temperature. See also section *Frost warning*, page 124.

### **Tripmeter**

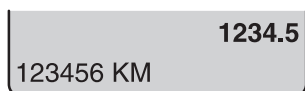

1234.5  
123456 KM

To reset, press and hold the **RE/SET** button.

### **Odometer**



1234.5  
123456 KM

### **Distance to empty**

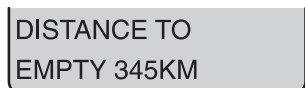

DISTANCE TO  
EMPTY 345KM

Indicates the approximate distance the vehicle will travel on the fuel remaining in the tank. Changes in driving pattern may cause the value to vary.

Refer also to the section *Low fuel level warning* on page 124.

### **Average speed**

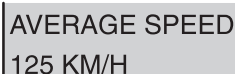

AVERAGE SPEED  
125 KM/H

Indicates the average speed calculated over the last 1 000 km or since last reset.

To reset, press and hold the **RE/SET** button.

### **Average fuel consumption**

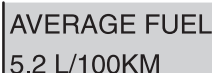

AVERAGE FUEL  
5.2 L/100KM

Indicates the average fuel consumption since the function was last reset.

To reset, press and hold the **RE/SET** button.

### **Fuel economy** (depending on country)

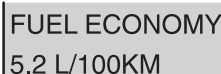

FUEL ECONOMY  
5.2 L/100KM

Indicates the instantaneous fuel consumption of the vehicle.

## Vehicle information systems

### Warning/information messages

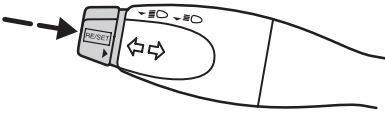

Each time a warning message appears in the display, the driver must acknowledge it by pressing the **RE/SET** button. The display then returns to the one previously shown.

Repeat this if further warning messages appear.

Information messages do not have to be acknowledged and will disappear automatically after a short period of time.

Once acknowledged, the warning message(s) will appear in the *Main menu* in the position **WARNING/INFO MESSAGES** shown in the diagram on page 24 and keep present until the problem has been solved.

When scrolling through the *Main menu*, the warning messages will appear one after the other for approximately two seconds each and do not have to be acknowledged with the **RE/SET** button.

**PLEASE CHECK  
OWNER'S GUIDE**

**ENGINE SYSTEM  
FAULT**



The messages are supplemented by a warning light next to the display, some additionally by the text **PLEASE CHECK OWNER'S GUIDE**.

Information messages are indicated by the warning light illuminating amber.

Warning messages are indicated by the warning light illuminating red.

1234.5  
123456 KM



If a warning/information message accompanied by the warning light is present, the warning light will remain illuminated.

## Vehicle information systems

Message	Warning light	System	See page
LOW BRAKE FLUID LEVEL	red	Brakes	98, 99
HIGH ENGINE TEMPERATURE	red	Cooling system	19, 169
TRANSMISSION MALFUNCTION	red	Automatic transmission, Durashift EST	113, 122
STEERING ASSIST FAILURE	red	Power steering	123
ENGINE SYSTEM FAULT	amber/red	Engine	123
LOW OUTSIDE TEMPERATURE	amber/red	Driving	124
TRANSMISSION HOT MODE	amber	Automatic transmission	113
LEFT INDICATOR BULB FAILURE	amber	Lights	52
RIGHT INDICATOR BULB FAILURE	amber	Lights	52

## Vehicle information systems

Message	Warning light	System	See page
DRIVER DOOR OPEN	amber	Locks	67
DRIVER SIDE REAR DOOR OPEN	amber	Locks	67
PASSENGER DOOR OPEN	amber	Locks	67
PASSENGER SIDE REAR DOOR OPEN	amber	Locks	67
BOOT OPEN	amber	Locks	67
BONNET OPEN	amber	Locks	67
REMOTE KEY BATTERY LOW	amber	Locks	72
FAILURE AUTO LAMP / WIPER	amber	Exterior lights, screen wiping/washing	46-47, 55-56

## Vehicle information systems

Message	Warning light	System	See page
SELECT NEUTRAL	amber	Durashift EST	105-106
PRESS BRAKE TO START	amber	Durashift EST	105-106
DOOR OPEN APPLY BRAKE	amber	Durashift EST	120
SELECT N OR P TO START	amber	Automatic transmission	105
DOOR OPEN NOT IN PARK	amber	Automatic transmission	108
HOME SAFE LIGHTS ON	amber	Lights	48
VOICE CONTROL LISTENING	amber	Voice control	_1
VOICE CONTROL NOT RECOGNISED	amber	Voice control	_1
VOICE CONTROL OUT OF RANGE	amber	Voice control	_1

<sup>1</sup> See separate manual.

## Vehicle information systems

### Time setting

**Note:** On vehicles with a compatible audio system, setting the time is only possible via the audio system. Please see chapter *Quick start*, page 9, or the separate manual.

The menu is only available when the vehicle is stationary.

SET TIME

- Press and hold the **RE/SET** button to open the menu.

TIME SETTING  
10:38  
SHORT PRESS ALTER  
LONG PRESS SELECT

The hours flash.

- To advance the hours, press the **RE/SET** button briefly. Each press advances the time by one hour.
- To change to the minutes, press and hold the **RE/SET** button.

TIME SETTING  
10:38

The minutes flash.

- To advance the minutes, press the **RE/SET** button briefly. Each press advances the time by one minute.

- To change to the date, press and hold the **RE/SET** button.

DATE SETTING  
01/06/05  
SHORT PRESS ALTER  
LONG PRESS SELECT

The day flashes.

- Repeat the procedure used for hours and minutes to set the day, the month and the year.
- To exit the menu after selecting the year, press and hold the **RE/SET** button.

EXIT TIME SETTING  
TIME 10:38  
DATE 01/06/05  
LONG PRESS TO  
CONFIRM

- Press and hold the **RE/SET** button to save the settings and to close the menu.
- Press the **RE/SET** button briefly to return to the time setting without saving any changes.

The menu is left automatically without saving any changes, if the **RE/SET** button is not pressed for approximately 20 seconds.

## Vehicle information systems

### Settings menu

**Note:** For road safety reasons, changes in the *Settings menu* can only be made while the vehicle is stationary. If this menu or one of its sub-menus is open when the vehicle begins to move, the Message Centre will automatically exit the *Settings menu*.

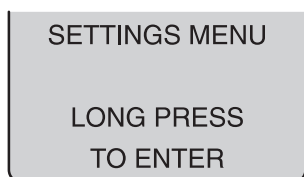

- Press and hold the **RE/SET** button to open the menu.  
For an overview of the functions available, see page 32.
- Press the **RE/SET** button briefly to toggle between the displays.
- When the corresponding display appears press and hold the **RE/SET** button to adjust the settings.

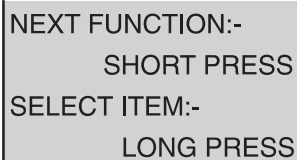

If the **RE/SET** button is not pressed for about 7 seconds, this message is shown to remind you of the procedure.

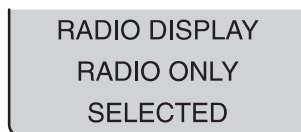

- If you changed a setting, a message like this appears in the display as confirmation.
- The settings will be saved permanently to the Message Centre.



## Vehicle information systems

### Setting menu displays

- Press and hold the **RE/SET** button to enter the *Settings menu*.
- Press the **RE/SET** button briefly to toggle between the displays.
- When the corresponding display appears press and hold the **RE/SET** button to adjust the settings.

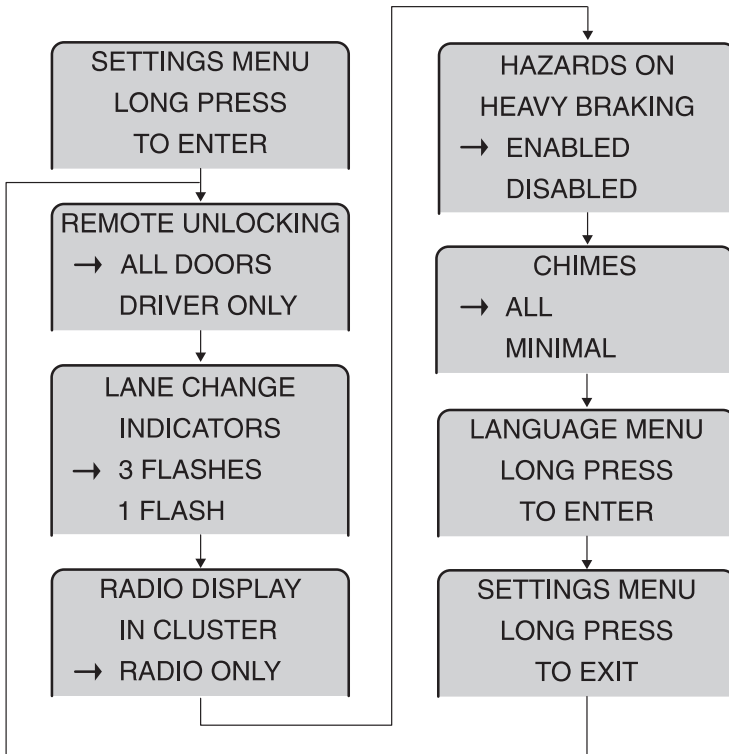

## Vehicle information systems

### **Remote control unlocking function**

REMOTE UNLOCKING  
→ ALL DOORS  
DRIVER ONLY

**ALL DOORS:** all doors will be unlocked when the  button on the remote control is pressed once.

**DRIVER ONLY:** only the driver's door will be unlocked when the button is pressed once.

For further information about this feature, see section *Reprogramming the unlocking function*, page 70.

### **Lane change indicators**

LANE CHANGE INDICATORS  
→ 3 FLASHES  
1 FLASH

**3 FLASHES:** if the multifunction lever is tapped up or down, the direction indicators will flash three times.

**1 FLASH:** the lane change indicators function is deactivated.

For further information, see section *Multifunction lever*, page 51.

### **Radio display**

(depending on the audio system equipped)

RADIO DISPLAY  
IN CLUSTER  
→ RADIO ONLY

**IN CLUSTER:** the display of the audio system is repeated in the message centre display.

**RADIO ONLY:** the radio display in the message centre is deactivated.

For further information about audio systems see the separate manual.

### **Hazards on heavy braking**

(depending on country)

HAZARDS ON HEAVY BRAKING  
→ ENABLED  
DISABLED

**ENABLED:** if the brakes are applied abruptly (e. g. in case of an emergency braking), the hazard lights will automatically flash for a minimum of three times.

**DISABLED:** the feature is deactivated.

For further information about this feature, see section *Hazards on heavy braking feature*, page 100.

## Vehicle information systems

### Chimes

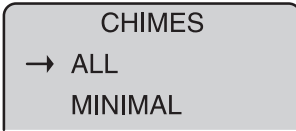

**ALL:** all chimes are activated.

**MINIMAL:** the following chimes are deactivated:

- **RE/SET** button press confirmation.
- Low outside temperature warning at temperatures under +4 °C.
- Distance to empty warning at remaining fuel for 80, 40 and 20 km.

### Setting the language

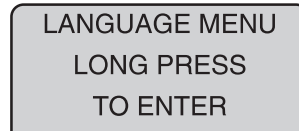

- Press and hold the **RE/SET** button to open the menu.

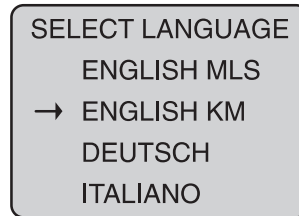

- Press the **RE/SET** button briefly to toggle between the languages.
- When the desired language is marked, press and hold the **RE/SET** button.

## Vehicle information systems

ENGLISH KM  
SELECTED  
LONG PRESS  
TO CONFIRM

- When the message like this appears, press and hold the **RE/SET** button to confirm and to return to the *Settings menu*.

- Press the **RE/SET** button briefly to stay in the *Language menu* without changing the setting.

If the button is not pressed for approximately 5 seconds, the display returns to the *Settings menu*. Any changes to the language settings will not be saved.

### **Measure units**

Imperial measure units (miles, mpg, mph) are only available with the language setting *ENGLISH MLS*.

All other language settings use metric measure units (km, l/100 km, km/h).

### **Settings menu – Exit**

SETTINGS MENU  
LONG PRESS  
TO EXIT

To exit the *Settings menu*, scroll to this display and press and hold the **RE/SET** button.

The *Settings menu* is left automatically, if the **RE/SET** button is not pressed for approximately 20 seconds. Any changes to the settings will be saved.

## Climate controls

### HEATING, VENTILATION AND AIR CONDITIONING

#### Outside air

Always keep the air intakes forward of the front screen free of snow, leaves etc., to allow the system to function effectively.

#### Recirculated air (if equipped)

When recirculated air is selected, only the air currently in the passenger compartment will be circulated. Outside air will not enter the vehicle.

**Note:** It is not recommended to use recirculated air for more than 30 minutes as there is no air exchange and the windows may mist up.

#### Fresh air filter/active carbon filter (if equipped)

The fresh air filter removes most potentially harmful particles such as pollen, industrial fallout and road dust from entering the vehicle's interior. The active carbon filter removes odours.

In an automatic car wash, you should switch off the ventilation blower or switch to recirculated air (if equipped) to prevent the filter collecting wax deposits.

#### Blower

The blower motor produces the ventilation air flow and may emit noises.

#### Side window demisters

When driving these vents provide a constant air stream to the side windows. This helps to keep the side windows free of mist and ice.

#### Centre and side vents

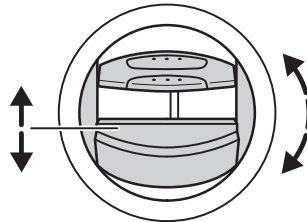
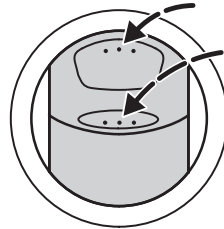

The centre and side vents enable efficient ventilation of the passenger compartment and should be used when the cooling of the compartment is required.

## Climate controls

The side vents can also be used to remove mist and ice from the side windows. Make sure not to adjust them straight upwards as they can also divert the air stream coming out of the side window demisters (see also position **A** on the instrument panel overview, page 14 onwards).

In winter, after the passenger compartment has been warmed up, the air from the centre vents has a lower temperature than the air from the side vents. According to individual preferences, the centre vents can be closed in cold weather, or opened for extra fresh air when heating.

### Heating

The heating depends upon the coolant temperature and is therefore only effective when the engine is warm.

### Air conditioning (if equipped)

The air is directed through the evaporator/heat exchanger where it is cooled if the air conditioning is switched on. In addition, humidity is extracted from the air to help keep the windows free of mist.

The resulting condensation is directed to the outside of the vehicle. It is therefore quite normal if you notice a small pool of water underneath the parked vehicle.

**Note:** The air conditioning system only operates when the temperature is above +5 °C, the engine is running and the blower is switched on. Operating the air conditioning leads to higher fuel consumption. However, also opening windows for additional cooling leads to increased fuel consumption, especially at higher road speeds.

### General notes on controlling the climate in the vehicle's interior

Close all the windows completely.

To warm the interior effectively, direct the heated air to the footwell area. In very cold or humid weather, direct air towards the front screen and side windows as necessary to prevent from misting or icing.

To cool the interior effectively, direct the cooled air from the centre and side vents towards the face level.

# Climate controls

## CONTROLS

If your vehicle is equipped with an Electronic Automatic Climate Control, please see the corresponding section, page 41 onwards.

### Blower

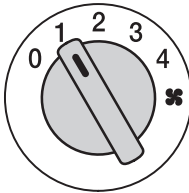

The blower is off in the **0** position.

To increase the blower speed, select a higher number.

With the blower turned off, the ventilation air flow depends only on the road speed and window misting may occur under adverse conditions.

### Adjusting the temperature





Blue: Cold

Red: Warm

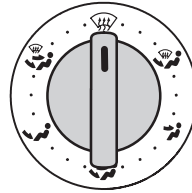
### Air distribution control



Directs the main air flow as follows:

-  **Front screen**
-  **Footwell/front screen**
-  **Face level**
-  **Face level/footwell**
-  **Footwell**
-  **Front screen/face level/footwell**

A minor portion of the air flow is always directed towards the front screen.

The air distribution control can be set to any position between the symbols.

## Climate controls

### HEATING AND VENTILATION

#### Rapid screen defrosting/ demisting

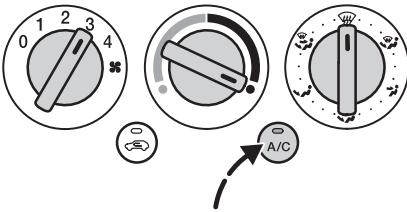



Select maximum temperature, set the air distribution control to  and the blower to position **3** or **4**.

Switch on the air conditioning (if equipped) to support demisting.

If necessary, turn the heated rear and front screens on (see page 45).

### Ventilation



Set the air distribution control to the positions ,  or . Set the blower to any position. Open the centre and side vents to suit individual requirements.

### Rapid heating of vehicle interior





# Climate controls

## MANUAL AIR CONDITIONING

### Switching the air conditioning on/off

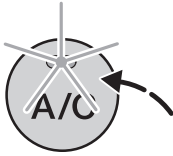

To switch the cooling effect on and off, press the **A/C** switch.

If the blower is turned to position **0**, the air conditioning will turn off. When the blower is turned on again, the air conditioning will reactivate automatically.

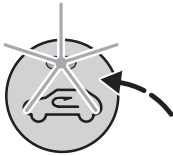

### Switching the recirculated air on/off

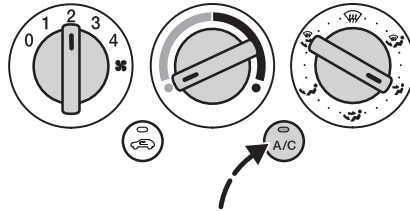

Press the button to toggle between outside air and recirculated interior air.

### Cooling with outside air





It is recommended to cool the vehicle with the air distribution set to  or .

In warm and humid weather, directing cooled air to the front screen  may lead to a small amount of condensation on the outside surface of the front screen.

### Rapid cooling of the vehicle interior

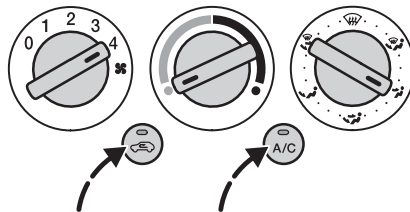
After the vehicle has parked in the sun, drive with the windows open for a short while, to exchange the hot air in the interior with cooler outside air. Afterwards, the air conditioning system can be used more efficiently.



For rapid cooling, switch on recirculated air and select .

## Climate controls

### Reducing air humidity in position

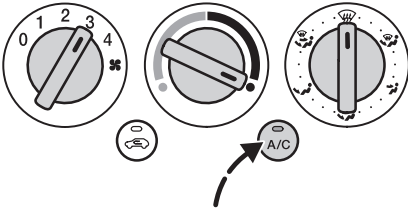

Switching the air conditioning on extracts humidity from the air and demists the windows faster.

### ELECTRONIC AUTOMATIC CLIMATE CONTROL

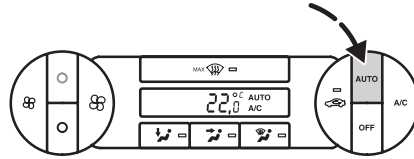

The temperature, amount and distribution of the air flow are controlled automatically and adjusted according to the driving and weather conditions. Pressing the **AUTO** button switches on the AUTO mode.

The recommended system settings for all seasons are 22 °C and AUTO mode (the air conditioning is switched on).

The individual settings can be adjusted as necessary.

To return to AUTO mode, press the **AUTO** button.

Avoid adjusting the settings when the vehicle interior is extremely hot or cold. The Electronic Automatic Climate Control adjusts to the current circumstances automatically.

## Climate controls

For the system to function properly and without restrictions, the side and centre vents should be fully open, especially in summer.

The sensor which measures the interior temperature is located underneath the climate control panel in the centre console (see also position ① on the instrument panel overview, page 14 onwards).

The sunload sensor is located on top of the instrument panel. The sensors should not be covered by any objects.

At low outside temperatures, when the system is in AUTO mode, the air stream will be directed to the front screen and the side windows as long as the engine is cold. The heating of the passenger compartment will commence as soon as a minimum air temperature can be delivered by the engine or by the auxiliary heater (where fitted).

### Setting the temperature

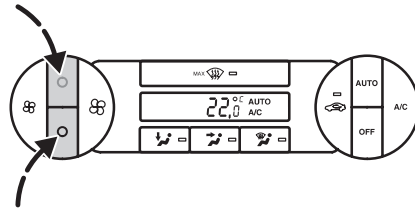

Blue button: lower temperature.

Red button: higher temperature.

The temperature can be set between 16 °C and 28 °C in steps of 0.5 °C using the buttons. In position **LO** (below 16 °C) the system will switch to permanent cooling, in **HI** (above 28 °C) to permanent heating, and not regulate a stable temperature.

## Climate controls

### Setting the blower speed

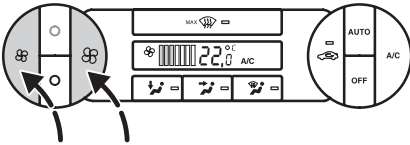

Press the left-hand button  to reduce the blower speed and thus the amount of air.

Press the right-hand button  to increase the blower speed and thus the amount of air.

The blower setting is indicated in the display.

### Setting the air distribution

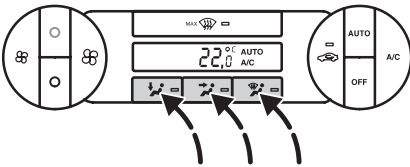



Directs the air flow as follows:

 **Footwell**

 **Face level**

 **Front screen**

Any combination of settings ,  and  can be selected simultaneously.

### Screen defrosting/demisting

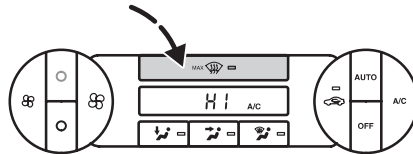

As long as the  button is selected, recirculated air cannot be selected and the air conditioning cannot be switched off. The blower speed and temperature are set to maximum performance automatically and cannot be adjusted manually.

When  is selected, the heated screens switch on automatically.

If the  button is pressed again, the system returns to the previous setting. The heated screens switch off automatically after a short time.

### Switching the recirculated air on/off

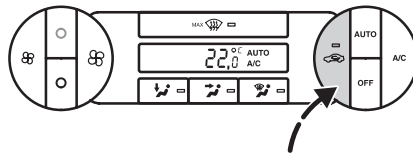

Press the button to toggle between outside air and recirculated interior air. The light in the button indicates operation.

# Climate controls

## Automatic recirculated air control

When the system is in AUTO mode and the interior and exterior temperatures are quite hot, recirculated air is selected automatically to maximise cooling of the interior.

Once the selected temperature is reached, the system will automatically change to the outside air position. The indicator light in the button does not illuminate during the automatic operation.

## Switching the air conditioning on/off

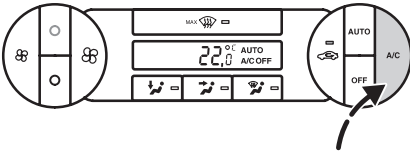

Press the **A/C** button to switch the air conditioning on/off. **A/C OFF** appears in the display when the air conditioning is switched off.

**A/C** appears in the display when the air conditioning is switched on.

## Switching the Electronic Automatic Climate Control on/off

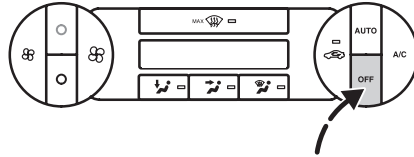

Press **OFF** to switch off the Electronic Automatic Climate Control. The settings remain stored.

The heating, ventilation and air conditioning system is switched off and recirculated air is selected.

**Note:** This setting is recommended only when driving with the windows and/or sunroof open. This ensures that the automatic function does not work against the additional air flow through the windows and/or sunroof.

Press **OFF** again or **AUTO** to switch the system back on. If another button is pressed, the stored settings will be changed accordingly when the system is switched on.

## Climate controls

### HEATED FRONT AND REAR SCREEN

Use for quick defrosting or demisting of the front or rear screen. It should be switched on only if necessary.

On vehicles with Electronic Automatic Climate Control, when MAX  is selected, the heated screens switch on automatically and switch off after a short time.

### Heated front screen switch

The system operates only when the engine is running.

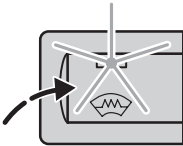

Press the switch to turn on or off. The light in the switch indicates operation.

The heating system switches off automatically after 4 minutes.

### Heated rear screen switch

Switch on the ignition first.

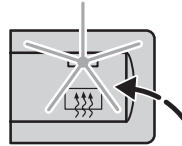

Press the switch to turn on or off. The light in the switch indicates operation.

Electrically operated door mirrors also have a heating element to clear the glass. This system operates when the heated rear screen is switched on.

The heating system switches off automatically after a short period.

### AUXILIARY HEATER (vehicles with a diesel engine – depending on country)

The auxiliary heater aids in warming the interior compartment and also the engine on vehicles with diesel engines. It delivers warm air quickly after engine start, even if the engine is not warmed up yet. It is automatically switched on or off depending upon the outside temperature, the coolant temperature and the alternator load.

# Lights

## EXTERIOR LIGHTS

An audible signal will be heard if the driver's door is opened with the exterior lights switched on and the ignition switched off.

### Exterior lights switch

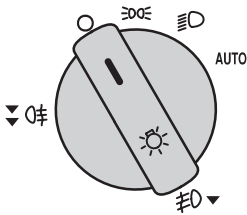

- **Lights off**
- ☰☷ **Side and tail lights**
- ☰☷ **Headlights**

The headlight beam direction should be altered to suit driving on the left- or right-hand side of the road. Please consult an expert.

## AUTO Autolamps (depending on model variant)

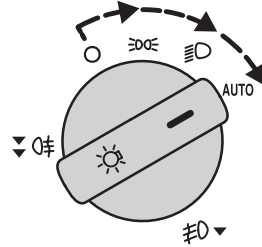

When the light switch is set to position **AUTO**, the dipped beam headlights will switch on and off automatically depending on the ambient light. The Autolamps are activated only when the ignition is switched on (position II).

 The Autolamps feature is an auxiliary system which is not intended to relieve the driver of his responsibility for the vehicle's exterior lighting.



**Note:** In **AUTO** mode, main beam can be activated only when the Autolamp feature has turned on the headlights.

In **AUTO** mode, if the headlights go off automatically with main beam activated, the next time the Autolamp feature turns on the headlights main beam will still be on. Dipped beam may be selected by pulling the multifunction lever towards the steering wheel. Refer to the section *Multifunction lever*, page 51 onwards.

**Note:** It is not possible to switch on the front or rear fog lights when the exterior lights control is set to **AUTO**. To switch on the front and/or rear fog lights, turn on the headlights by setting the control to position .

FAILURE AUTO  
LAMP / WIPER

On vehicles with a Message Centre, if this message appears in the display and the display warning light illuminates amber, it indicates a malfunction.

Switch the headlights on (position ) and off (position ) manually and have the system checked by an expert.

## Headlight indicator light



The headlight indicator light illuminates when the headlights or the side and tail lights are on.

## Front fog lights

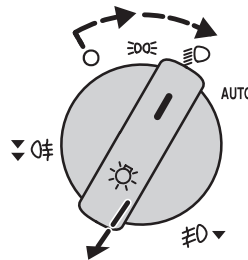

Switch on the headlights (position ) and pull out the control switch one position.





The indicator light in the instrument cluster will illuminate when the front fog lights are in use. The **front fog lights** should be used only when visibility is considerably restricted by fog, snow or rain.

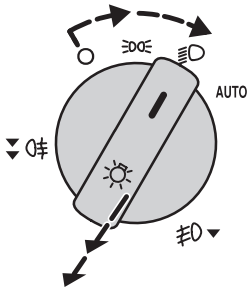

# Lights

## Front and rear fog lights



Switch on the headlights (position ) and pull out the control two positions.

On vehicles not equipped with front fog lights the control switch can be pulled out only one position.

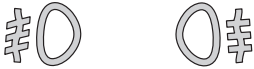

Both indicator lights in the instrument cluster will illuminate when the front and rear fog lights are switched on.







The **rear fog lights** may only be used when visibility is restricted to less than 50 m and must **not** be used when it is raining or snowing.

## Home safe lights

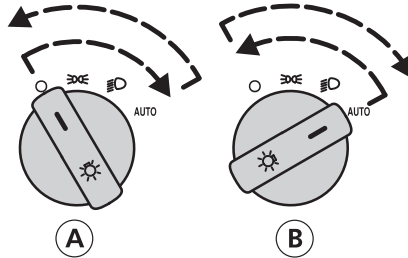
Within the first 10 minutes after the ignition is switched off the headlights can be switched on. They will then be switched off automatically after a period of time.

On vehicles **with** Autolamps,



- (A) turn the exterior lights switch from the position  to position **AUTO** and back to position  within 2 seconds, **or**
- (B) turn the exterior lights switch from the position **AUTO** to position  and back to position **AUTO** within 2 seconds.

## Lights

On vehicles **without** Autolamps,

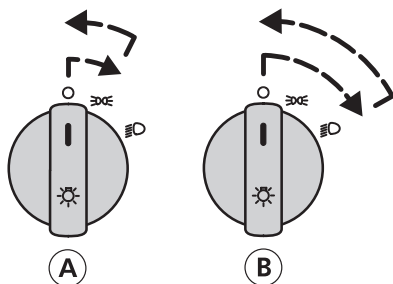

- (A) turn the exterior lights switch from the position **O** to position **P** and back to position **O** within 2 seconds, **or**
- (B) turn the exterior lights switch from the position **O** to position **H** and back to position **O** within 2 seconds.

HOME SAFE  
LIGHTS ON

In addition, on vehicles with a Message Centre, this message will appear in the display and the display warning light illuminates amber.

The lights will switch off automatically:

- as soon as the exterior lights switch is turned to any position,
- as soon as the ignition is switched on (position **II**),
- as soon as any door or the tailgate is unlocked using the remote control,
- after 3 minutes, if any door or the tailgate is open, or
- after 30 seconds if all doors and the tailgate are closed.

### Welcome lights

Depending on model variant, the side and tail lights are switched on automatically when the vehicle is unlocked using the radio frequency remote control.

The lights switch off automatically

- after 25 seconds,
- or 5 seconds after all opened doors are closed,
- or as soon as the ignition is switched on or the vehicle is locked.

# Lights

## Headlight levelling control

The level of the headlight beams can be adjusted according to the vehicle load.

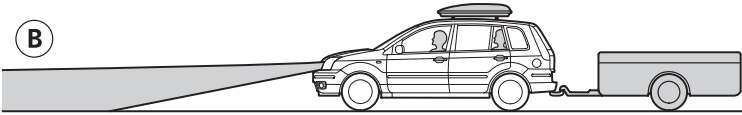
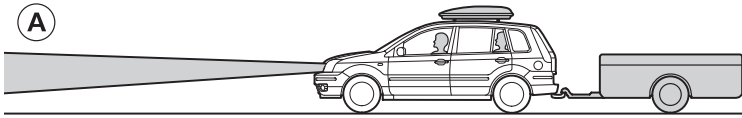
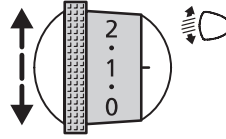

- (A) Without headlight levelling
- (B) With headlight levelling

Recommended headlight levelling control positions			
Load			Control positions
Persons		Load in luggage compartment	
Front seats	Rear seats		
1-2	–	–	0
1-2	3	–	1
1-2	3	max. <sup>1</sup>	1.5
1	–	max. <sup>1</sup>	2

<sup>1</sup> Data can be found in the section *Vehicle weights* from page 175 onwards. Higher control positions (+1) may be necessary when towing a trailer.

## Multifunction lever

The following functions will operate only with the ignition switched on.

### **Direction indicator**

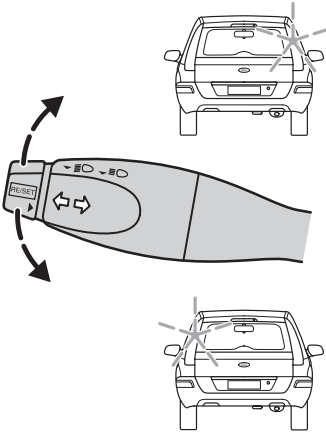

### • **Lane change indicators function**

If the lever is tapped up or down, the direction indicators will flash three times.

To activate/deactivate this feature, see section *Settings menu*, page 31 onwards.

### • **Hazards on heavy braking**

If the brakes are applied abruptly (e. g. in case of an emergency braking), the hazard lights will automatically flash for a minimum of three times.

For further information, see section *Hazards on heavy braking feature*, page 100.

# Lights

## Direction indicator light

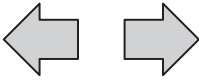

A sudden increase in the rate of flashing warns of a failed indicator bulb.

RIGHT INDICATOR  
BULB FAILURE

LEFT INDICATOR  
BULB FAILURE

In addition, on vehicles with a Message Centre, one of these or both messages will appear in the display and the display warning light illuminates amber.

See also section *Warning/information messages*, page 26 onwards.

If your vehicle has been equipped with factory fitted or original Ford towing equipment, the indicator light also warns of failure of the indicator bulbs on the trailer.

## Main/dipped beam

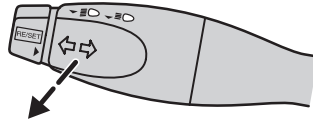

The main beam only operates with the headlights switched on.

Pull the lever towards the steering wheel to toggle between main and dipped beam.

## Headlight flasher

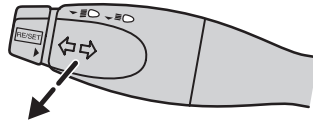

Pull the lever slightly towards the steering wheel.

## Main beam indicator light



Illuminates when the headlights are on main beam or when the headlight flasher is used.

## INTERIOR LIGHTS

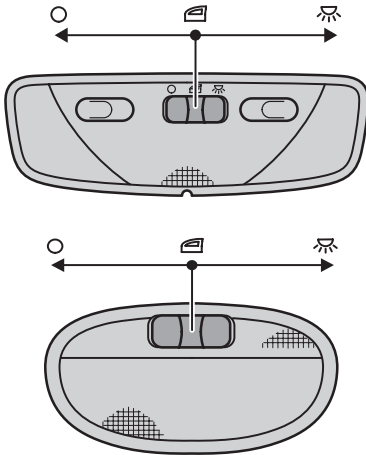

- Off
- ☏ Door contact
- ☀ On

On some models, with the switch in the ☏ position, the interior lights will stay on for a while after the doors are shut. They go off immediately after the ignition is turned on.

When parking your vehicle with the doors open for a long period of time, the interior lights and the luggage compartment light are switched off automatically after 10 minutes. If the interior lights are left in the ☀ position, they will be switched off after 30 minutes.

To switch the lights back on, switch on the ignition (position II) for a short time, open a door or press the ☐ button of the radio frequency remote control.

## Reading lights

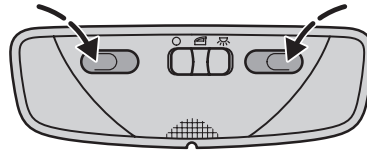

## Reading lights (depending on model variant)

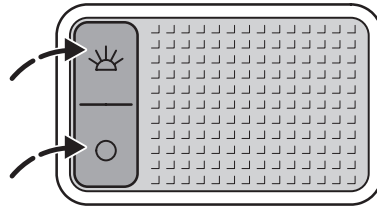

- ☀ On
- Off

## Driver controls

### STEERING WHEEL ADJUSTMENT



Never adjust the steering wheel when the vehicle is moving.

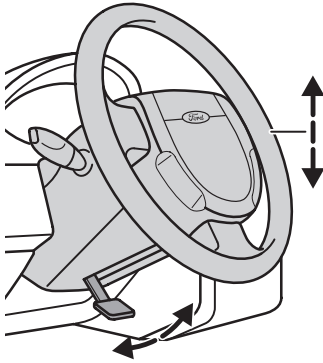

Release the locking lever to adjust the height of the steering wheel.

Return the lever to its original position to secure the wheel.

For further details on sitting in the correct position, refer to section *Seats*, page 77.

### HORN

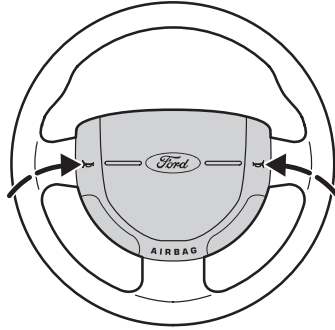

The horn can also be operated when the ignition is off.

## Driver controls

### SCREEN WIPER/WASHER CONTROLS

The following functions will operate only with the ignition switched on.

#### Front screen

#### Lever positions:

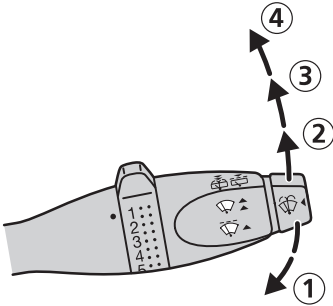

- ① Single wipe
- ② Intermittent wiping or Autowipers (depending on model variant)
- ③ Normal wiping
- ④ High speed wiping

#### To set the intermittent wipe interval:

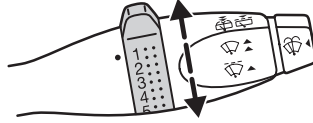

Select wipe interval with rotary switch:

- 1 = Short time interval
- 6 = Extended time interval

#### Autowipers (depending on model variant)

When Autowipers is selected (position ②), the wipers will cycle once regardless of whether the front screen is wet or dry.

Thereafter, or when the ignition is switched on with the wiper lever already in position ②, the wipers will not cycle until water is detected on the front screen.

The rain sensor will continuously measure the amount of water on the front screen and adjust the speed of the front wipers automatically (single wipe, intermittent, normal or high speed wiping).



## Driver controls

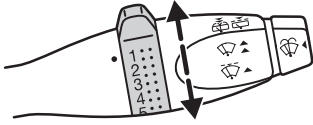

The sensitivity of the rain sensor is set using the rotary control:

**1** = High sensitivity: The wipers will wipe even if only a small amount of water is detected on the front screen.

**6** = Low sensitivity: The wipers will only wipe when a larger amount of water is detected on the front screen.

**Note:** The Autowipers feature is intended for use during wet weather conditions only and is very sensitive to anything which touches the front screen near to the rain sensor. Objects such as dirt, mist or flies hitting the screen in this location may cause the wipers to wipe even though the screen is mostly dry.

**Note:** The Autowipers function should not be selected when it is snowing or foggy, or when the roads have been salted. In these weather conditions, select position **1**, **3** or **4**, if necessary.

 In icy conditions, make sure that it has been fully defrosted before selecting autowipers.

 Switch off the Autowipers before entering a car wash.

 Replace the wiper blades as soon as they begin to leave bands of water and smears or when they do not completely remove water from the front screen. If the blades are not replaced, the rain sensor will continue to detect water on the screen. This will result in the wipers continuing to operate although the majority of the screen is dry.

### FAILURE AUTO LAMP / WIPER

On vehicles with a Message Centre, if this message appears in the display and the display warning light illuminates amber, it indicates a malfunction.

Switch the wipers on (position **1**, **3** or **4**, as necessary) and off manually and have the system checked by an expert.

## Driver controls

### Rear screen

#### Wiping

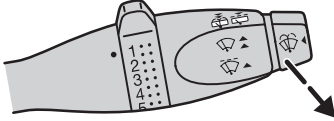

Pull the lever towards the steering wheel. The wiper delay is automatically set to match the front wiper setting.

#### Reverse gear wipe

If only the front wipers are activated, the rear screen wiper will be activated automatically when the reverse gear is selected. When the front screen wiper is switched off, the rear screen wiper will not work unless it is switched on manually.

### Washer

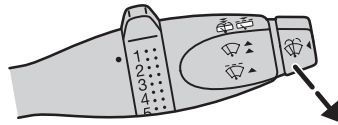
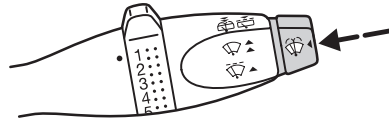

While the button at the end of the lever is pressed or the lever is pulled towards the steering wheel the washer will work in conjunction with the wipers.

Once the wash/wipe cycle is completed, the front wipers will pause and then perform one more wipe to clear the screen.



Do not operate the washer for more than 10 seconds at a time, and never when the reservoir is empty.

## Driver controls

### AUDIO REMOTE CONTROL

Select radio, CD or cassette mode on the radio.

The following functions can be operated with the remote control:

#### Volume

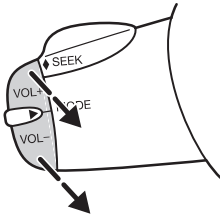

Volume up: Pull the **VOL+** switch towards the steering wheel.

Volume down: Pull the **VOL-** switch towards the steering wheel.

#### Seek

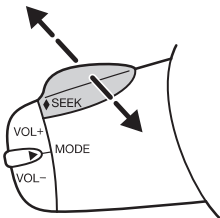

Move the **SEEK** switch towards the steering wheel or the instrument panel:

- In **radio mode**, this will locate the next radio station up or down the frequency band.

- In **CD mode**, it will select the next or the previous track.

#### Mode

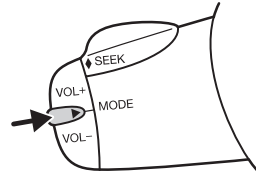

Briefly press the ► button on the side:

- In **radio mode**, this will locate the next pre-set radio station.

- In **CD mode**, it will select the next CD if a CD changer is fitted.

- In **all modes** to abort a traffic message during broadcasting.

Press and hold the ► button on the side:

- In **radio mode** to change the waveband.

For further details, please refer to the separate manual.

## Driver controls

### MIRRORS

#### Interior rear-view mirror

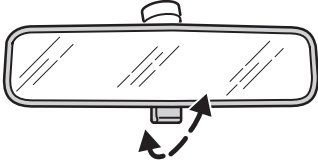

To reduce glare when driving at night dip the mirror by adjusting the lever.

#### Convex outside rear-view mirrors

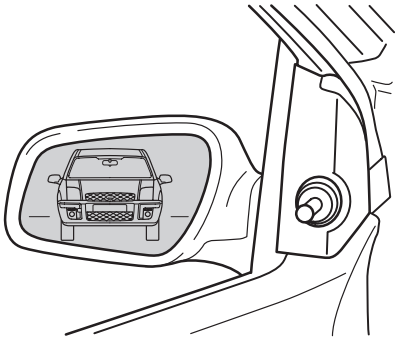

The rearward field of vision is increased to minimise blind spots at the rear corners of the vehicle.



Objects seen in these mirrors will look smaller and appear further away than they actually are. Be careful not to overestimate the distance of the objects seen in the mirrors.

#### Manually adjustable outside rear-view mirrors

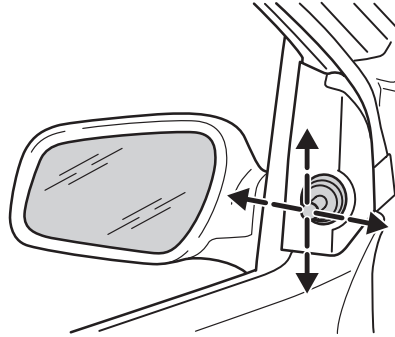

Both outside rear-view mirrors are adjustable from inside the vehicle.

#### Manually folding outside rear-view mirrors

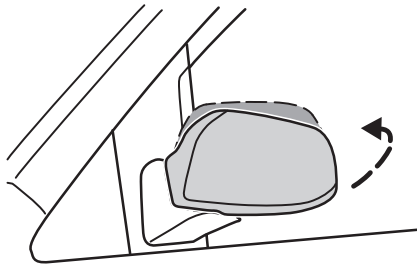

If required, in narrow spaces for example, your outside rear-view mirror can be folded back manually. To return the door mirror to its original position, push it into the mirror support until engaged.

## Driver controls

### Electrically operated and heated outside rear-view mirrors

The outside rear-view mirrors are heated when the heated rear screen is switched on.

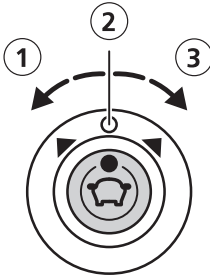

- ① Left-hand mirror
- ② Off
- ③ Right-hand mirror

### Mirror tilting positions

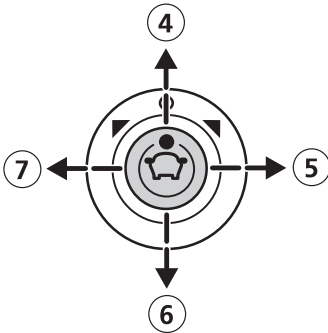

- ④ Up
- ⑤ Right
- ⑥ Down
- ⑦ Left

### Electrically operated folding function

(depending on model variant)

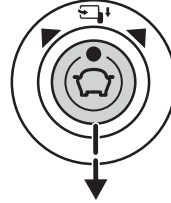

In the centre position push the control unit down. To return the door mirror to its original position, push the control unit down again.

If the mirrors are folded more than 10 times in 60 seconds they will de-activate for 3 minutes to prevent overheating. After 3 minutes the mirrors will return to normal operation.

### Automatic folding function

(depending on model variant)

The outside rear-view mirrors are folded back automatically:

- if the mirrors are not folded back using the control unit and
- if the vehicle is locked using the radio frequency remote control.

After the mirrors were folded back automatically, they unfold again automatically:

- if the vehicle is unlocked in any way, or
- if the ignition is switched on (position II).

## Driver controls

### FRONT POWER WINDOWS



Before operating power windows you should verify they are free of obstructions and ensure that children and/or pets are not in the proximity of window openings. Failure to do so could result in serious personal injury. It is the primary responsibility of the supervising adults never to leave a child unattended in a vehicle and never to leave the keys in an unattended vehicle.

Switch on the ignition to operate the power windows.

**Note:** When the switches are operated constantly, the system will automatically switch off for a short period of time to prevent overheating.

### To open/close the windows

The front windows can be operated with switches located on the door trim of the driver's door. The windows open/close when the switch is pressed. The front passenger's window can also be operated with a switch on the door trim of the passenger's door.

The windows open/close only when a button is pressed.

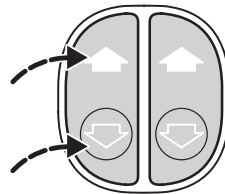

Press : to open.

Press : to close.

### To open the driver's window automatically

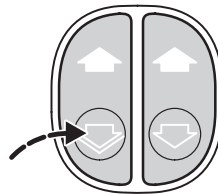

Briefly press button  to the second action point to open. Press again to stop the window.

## Driver controls

### OTHER CONTROLS

#### Sunroof

Always push the handle back into its recess after use.

#### *To open the sunroof*

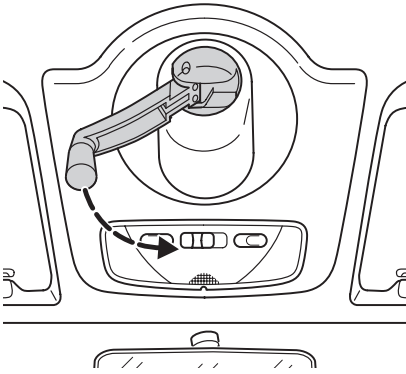

Pull out the handle and turn it anticlockwise to open the sunroof.

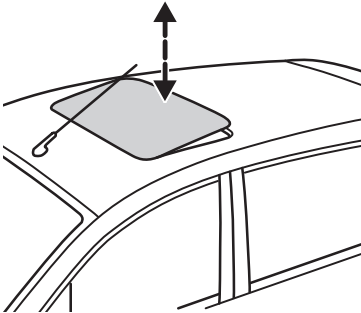

With the first two revolutions the rear of the sunroof will be lifted up.

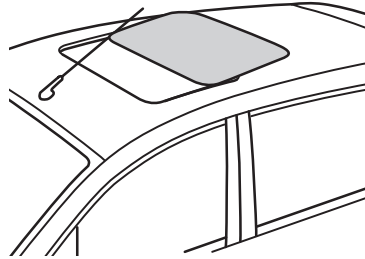

If you turn the handle further, the raised sunroof will open from the front and slide back over the roof.

#### *To close the sunroof*

Pull out the handle and turn it clockwise to close the sunroof.

#### Sun visors

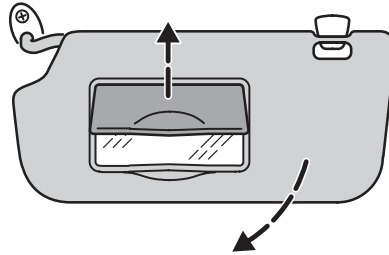



The sun visors can be released from the retention clips and swivelled towards the side window.

The mirror cover can be folded up.

## Driver controls

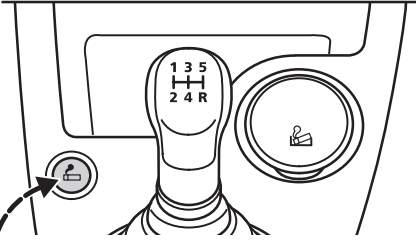
### Cigar lighter/power point



 Never hold the lighter in, as this will result in damage. Always remove the lighter as a precaution when children are left alone in the vehicle.

To use the lighter press it in and wait until it pops out automatically. The lighter will also operate when the ignition is switched off.

The lighter socket can also be used to power 12 volt appliances having a maximum current rating of 10 amperes. However, if the engine is not running, this will cause the battery to discharge.

When connecting appliances, use only specified connectors from the Ford Accessory range or connectors suitable for use with SAE standard sockets.

### Front ashtray

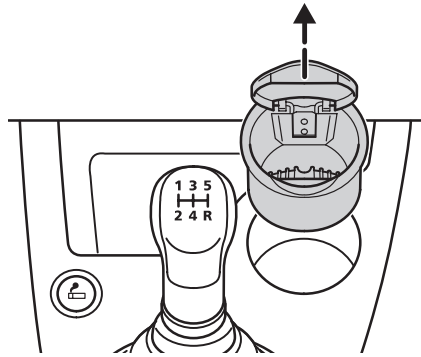

Pull the cover to open.

To empty, gently pull up on the open lid and extract the complete ashtray.



## Locks (security)

### KEYS

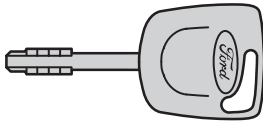

In case of loss, replacement keys are available from dealers by stating the key number shown on the tag provided with the original keys.

For further information, refer to section *Engine immobilisation system*, page 73.

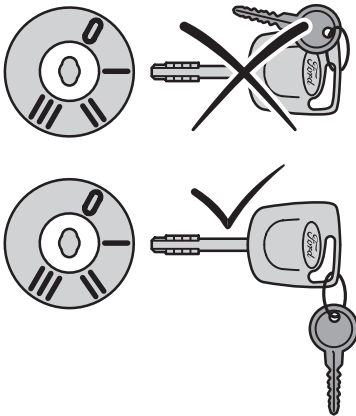

To ensure a trouble-free data exchange between the vehicle and key, do not shield the keys with any metal objects.

### Key with radio frequency remote control

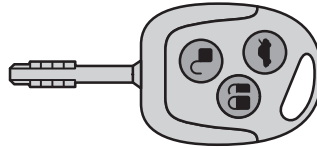



The transmitter is integrated into the key.

#### **General notes on the radio frequency remote control**

For type approval of your remote control, refer to the table on page 181.



The vehicle or luggage compartment will be unlocked if the  or  buttons are pressed unintentionally, without the remote control being directed towards the vehicle (e.g. in your pocket).

The range between transmitter and vehicle is environmentally influenced and varies greatly.

## Locks (security)

 The radio frequency used by the remote control can also be used by other short distance radio transmissions (e.g. amateur radios, medical equipment, wireless headphones, remote controls, alarm systems etc.). If the remote control frequencies are jammed, you will not be able to use any remote functions to lock or unlock the vehicle or set the alarm. However, you can lock/unlock with the key.

### LOCKS

#### From outside

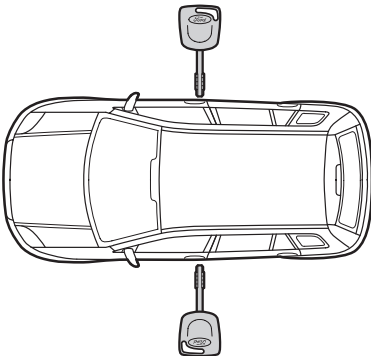

All doors can be locked and unlocked from the outside with the key on a front door.

**Note:** Only vehicles without remote control are equipped with a lock cylinder in the passenger's door.

#### From inside

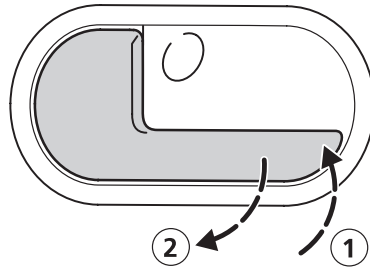

When inside the vehicle, all doors can be locked by depressing ① the door handle and unlocked by pulling ② the door handle.

## Locks (security)

### Rear door childproof safety locks

 When the childproof safety lock is activated, the door can only be opened from outside.

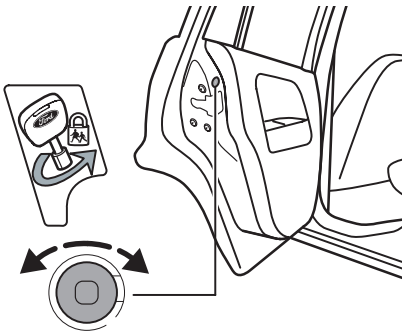

Turn the key in the rear doors rearward to activate the lock. To deactivate the lock, turn the key forward.

### Luggage compartment

#### *Opening the tailgate*

The luggage compartment light will come on automatically. If the luggage compartment remains open with the ignition switched off, the light will be switched off automatically after 10 minutes.

1. By pressing the Remote luggage compartment release on the instrument panel.

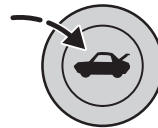

Vehicle speed must be below 7 km/h and the vehicle must be unlocked.

2. Using the key.



To unlock/open, turn the key clockwise.

3. Using the radio frequency remote control. See also section *To unlock the tailgate*, page 69.

## Locks (security)

### Closing the tailgate

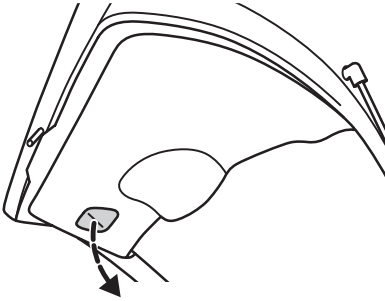

A recessed grip is incorporated inside the tailgate to facilitate closing.



Close the tailgate properly to prevent it opening while you are driving.

### Doors open warning



The doors open warning light illuminates when the ignition is switched on and remains on if any door, the luggage compartment or the bonnet is not closed properly.

DRIVER  
DOOR OPEN

DRIVER SIDE  
REAR DOOR OPEN

PASSENGER  
DOOR OPEN

PASSENGER SIDE  
REAR DOOR OPEN

BOOT  
OPEN

BONNET  
OPEN

On vehicles with a Message Centre, instead of the doors open warning light one or more of these messages will appear in the display and the display warning light illuminates amber.

See also section *Warning/information messages*, page 26 onwards.

## Locks (security)

### CENTRAL DOOR LOCKING SYSTEM

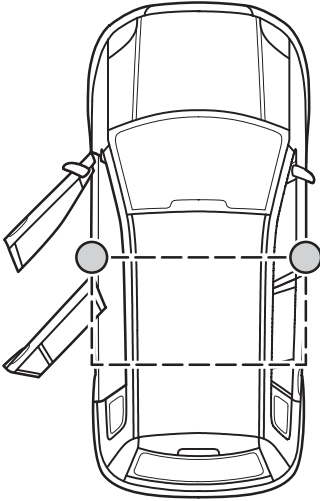

The central door locking system can be activated from the driver's or front passenger's door.

It operates only when both front doors are closed.

It is activated from the outside with the key or the remote control and from inside by pressing the door handle on the driver's door or (vehicles without remote control) the front passenger's door.

When the system is activated, the locking procedure is heard followed directly by a secondary noise. This secondary noise is a system check and does not indicate a malfunction.

To lock the rear doors and (vehicles with remote control) the front passenger's door individually, press the door handle and close the door when leaving the vehicle.

The luggage compartment remains locked when the system is deactivated.

### Central locking with double locking system

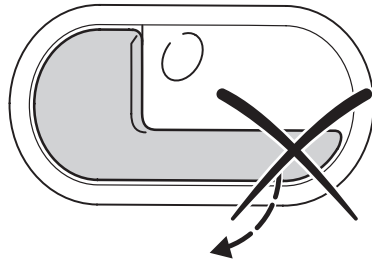

Double locking is an additional theft protection feature which prevents the vehicle's doors being opened from inside the vehicle.

 Double locking should not be activated when persons are inside the vehicle.

Double locking is possible only if the front doors are closed.

## Locks (security)

### Unlocking the vehicle

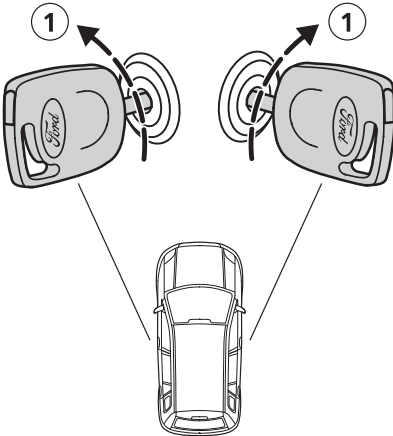

*With the key:* Turn the key in the driver's or front passenger's door to position ①.

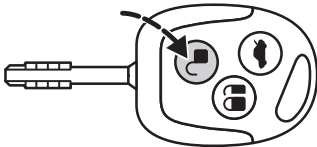

*With the remote control:* Press the  button once.

- The direction indicators will flash once to confirm that **all** doors are unlocked and the double locking and the anti-theft alarm system (if equipped) are deactivated.

**Note:** After 22 days the remote locking system will shut down to save the battery. It will be reactivated when the doors are unlocked with the key.

### Automatic relocking

**Note:** To prevent the vehicle being left unlocked inadvertently, central locking and the anti-theft alarm system will be reactivated automatically 45 seconds after the  button is pressed if the following occurs during this period:

- No door is opened.
- The luggage compartment is not opened.
- The ignition is not switched on.



If a failure occurs in the vehicle's electrical system, the front doors and the tailgate can still be individually unlocked with a key.

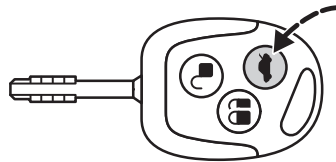

### To unlock the tailgate



Press the  button twice within 3 seconds.



## Locks (security)

### Reprogramming the unlocking function

You can change the unlocking function so that pressing the  button once deactivates the double locking and the anti-theft alarm system and unlocks only the driver's door. Pressing the  button again within 3 seconds also unlocks the passenger's doors.

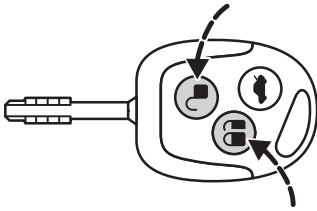
To re-programme the function, see section *Settings menu*, page 31 onwards, if a message centre is equipped.



In order to re-programme the function, press and hold the  and  buttons simultaneously for at least four seconds with the ignition switched off. The direction indicators will flash twice to indicate that the unlocking function has been successfully re-programmed.

Pressing and holding both buttons again simultaneously for at least 4 seconds will change the function back.

### Locking the vehicle

To activate central locking and arm the anti-theft alarm system (if equipped):

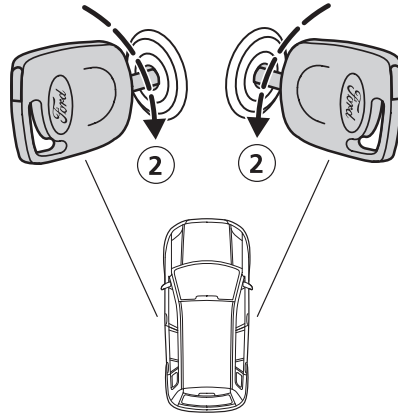

*With the key:* Turn the key in the driver's or front passenger's door to position ②.

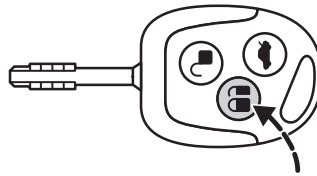

*With the remote control:* Press the  button once.

- On vehicles without double locking, the direction indicators will flash twice as confirmation.

## Locks (security)

To activate double locking and arm the anti-theft alarm system (if equipped):

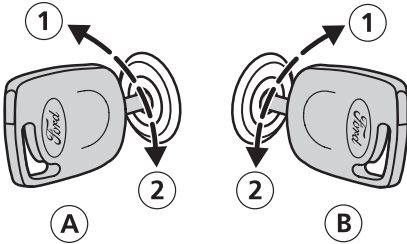

- (A) Left-hand door.
- (B) Right-hand door.

*With the key:* Turn the key in the driver's or front passenger's door to position ① and then to position ② within two seconds.

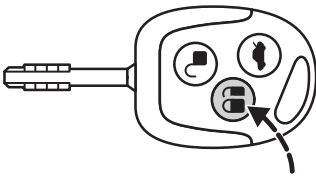

*With the remote control:* Press the  button twice within 3 seconds.

- The direction indicators will flash twice as confirmation.

### Programming additional radio frequency remote controls

A maximum of four radio frequency remote controls can be programmed (including the ones delivered with the vehicle).

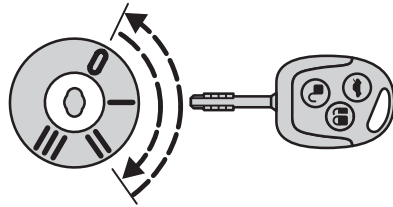

1. To programme new radio frequency remote controls turn the ignition key from position 0 to position II four times within six seconds.

2. Switch off the ignition. A tone sounds to indicate that it is now possible to programme new radio frequency remote controls for 10 seconds.



## Locks (security)

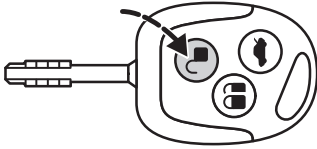

3. Press any button on a new radio frequency remote control. A tone will sound as confirmation. Repeat this last step for **all** your radio frequency remote controls, including your original ones, within 10 seconds.

4. Switch the ignition back on or wait for ten seconds without programming another remote control to end the programming. Only the radio frequency remote controls which you have just programmed are now able to lock and unlock the vehicle.

### **Replacing the remote control battery**

If the range of the transmitter in the key decreases gradually, the battery (type 3V CR 2032) should be replaced.

REMOTE KEY  
BATTERY LOW

In addition, on vehicles with a Message Centre, this message will appear in the display and the display warning light illuminates amber.

See also section *Warning/information messages*, page 26 onwards.

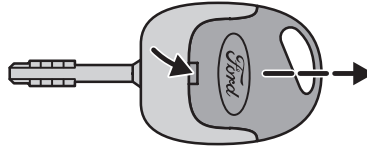

- Carefully separate the transmitter unit from the key using a flat object (e.g. a screwdriver) in the recess on the back.

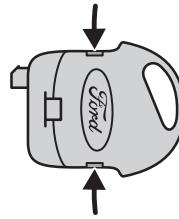

- Open the transmitter unit by separating the retaining clips on the sides with the flat object.

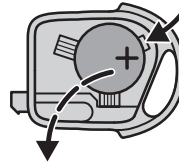

- Carefully prise out the battery with the flat object. Fit the new battery between the contacts with the (+) sign facing upwards. Reassemble the transmitter unit in reverse order.

## Locks (security)

### ENGINE IMMOBILISATION SYSTEM

The engine immobilisation system is a theft protection feature which prevents the engine from being started with an incorrectly coded key.

#### Coded keys

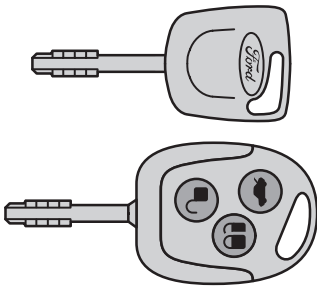

Your vehicle is supplied with coded keys.

Replacement keys must be recoded together with your other keys.

### Automatic arming

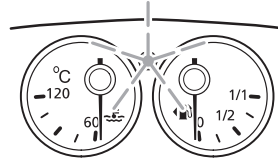

The system is armed after switching off the ignition. The Engine immobilisation system indicator light in the instrument cluster will **flash**.

### Automatic disarming

Switching on the ignition disarms the system if the correct code is recognised. The indicator light in the instrument cluster **illuminates** for approximately 3 seconds **and then extinguishes**.

If the indicator light **stays illuminated** or begins to **flash** rapidly, the system remains armed and the engine does not start. Remove the key and try again.

If the engine does not start, a system malfunction has occurred. Have the system checked by an expert immediately.

## Locks (security)

### Key coding

A maximum of eight keys (including the ones delivered with the vehicle) can be coded using two other keys previously coded for your vehicle.

Complete each of the following steps **within 10 seconds**.

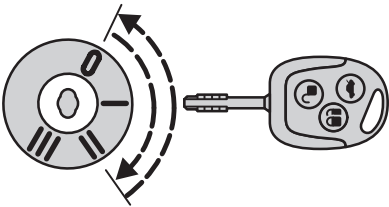

1. Insert the first key in the ignition switch and turn to position **II**.
2. Turn the key back to position **0** and remove from the ignition switch.
3. Insert the second key in the ignition switch and turn to position **II**.
4. Turn the second key back to position **0** and remove from the ignition switch – the key coding mode is now activated.

5. If an uncoded key is now inserted in the ignition switch and turned to position **II** within 20 seconds, this key is coded to the system.

6. After the coding process is completed remove the key from the ignition switch.

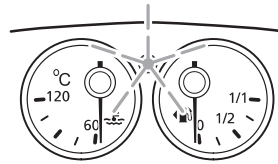

If coding is not completed correctly, the indicator light flashes after the ignition is switched on with the newly coded key and the engine will not start.



If a key is lost, it is imperative that the remaining keys are erased and recoded. Consult an expert if you now have only one valid key.

## Locks (security)

### Coding erasure

With two keys coded for your vehicle you can make all the other coded keys unusable, e.g. after loss.

Complete each of the following steps **within 10 seconds**.

Carry out the first four steps under *Key coding*, then continue as follows:

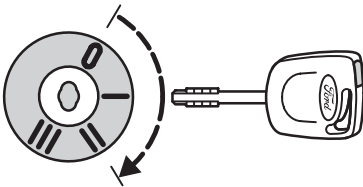

5. Insert the second key in the ignition switch again and turn to position **II**.

6. Remove the key from the ignition switch.

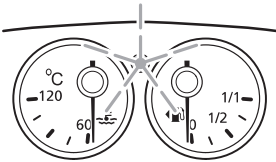

7. Insert the first key in the ignition switch, turn to position **II** and hold. The indicator light flashes for 5 seconds.

8. If the ignition is switched off during these 5 seconds, the erasure process is terminated and **no** key is erased.

9. If the erasure process is completed, all the other keys, apart from the two used for erasure, can no longer be used unless recoded.

Additional keys can now be coded.

## Locks (security)

### **ANTI-THEFT ALARM SYSTEM**

The system is armed as soon as the vehicle is locked and acts as a deterrent to unauthorised persons who attempt to open the doors, bonnet or luggage compartment.

#### **Automatic arming delay**

Up to 20 seconds after arming the anti-theft alarm system, it is still possible to open the vehicle again without triggering the alarm. After that, the anti-theft alarm system will monitor all doors, the bonnet and the tailgate, provided that they are closed. If a door, the bonnet or the tailgate is closed later, the system will monitor it after 20 seconds.

### **Alarm**

The alarm sounds for 30 seconds if an unauthorised person opens a door, the luggage compartment or the bonnet. The hazard flasher lights will flash for 5 minutes.

Any attempt to start the engine without a valid key sounds the alarm again.

#### **To switch off**

The anti-theft alarm system can be disarmed at any time – even when the alarm is sounding – by unlocking either of the front doors with the key or with the remote control.

The anti-theft alarm system on the tailgate is disarmed when the luggage compartment is unlocked with a key.

After closure, the alarm is once again armed.

## Seating and safety restraints

### SEATS

#### Sitting in the correct position

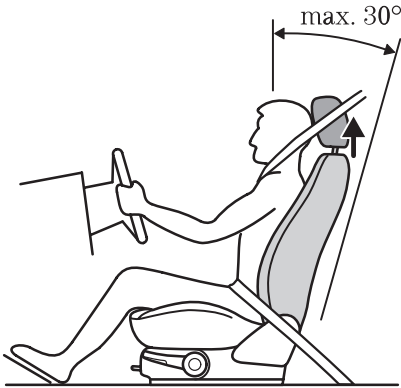

- Sit in an upright position with the base of your spine as far back as possible and with the seatback reclined no more than 30 degrees.
- Adjust the head restraints so that the top is level with the top of your head.
- Do not move the front seat too close to the instrument panel. The driver should hold the steering wheel in the '10 to 2 o' clock' position with arms slightly bent. The legs should also be slightly bent so that the pedals can be pressed fully to the floor.
- The seat belt should cross the centre of the shoulder; the lap strap should fit tightly across the hips, not the stomach.

 Do not use any accessory seat covers that are not specifically designed for seats with side airbags. These seat covers must be fitted by properly trained technicians.

 Do not adjust the seats while the vehicle is moving.

#### Moving the seats forwards or backwards

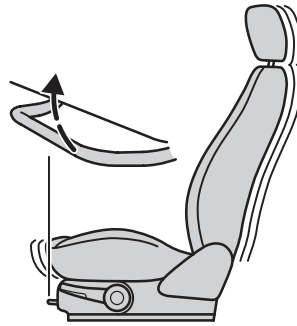

Pull the lever. Rock the seat to engage the catch.

## Seating and safety restraints

### Adjusting the height of the driver's seat

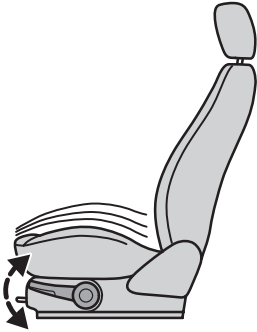

Each pull or press on the lever will raise or lower the height by a small amount.

### Adjusting the angle of the seatback

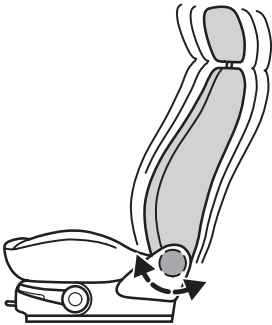

When the seats are slid fully forward the seatbacks can be fully reclined.

### Armrest

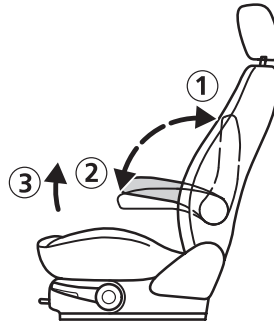

To adjust the driver's armrest to a comfortable height:

- Pull the armrest all the way back, past vertical ①.
- Push the armrest all the way down ②.
- Slowly raise the armrest to the desired position ③.

**Note:** If the armrest is too high, repeat the procedure.

## Seating and safety restraints

### Fold flat front passenger seat

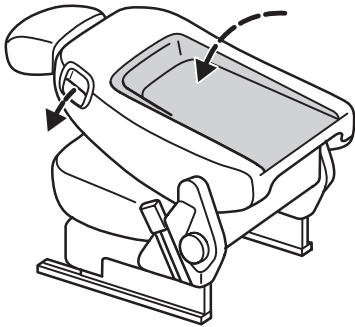

To fold the front passenger seat flat, pull the unlocking lever and fold the seatback forwards. Turn the handwheel at the side of the seat until the seatback reaches the horizontal position.

Pull the unlocking lever to return the seatback to the upright position.

When returning the seatback to the upright position, ensure that it locks with a distinct click.

 The front passenger seat must be in the upright position when driving if the seat directly behind it is occupied.



Only children up to 18 kg may travel on the rear seat when the passenger seat is folded flat.

 Do not place objects on the table surface when driving as these could become projectiles in the event of an accident or heavy braking.

### Heated front seats

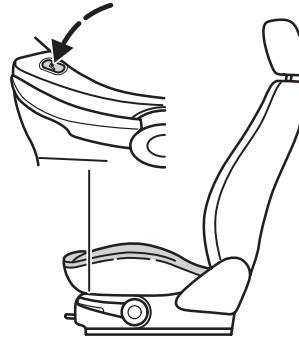

(A)

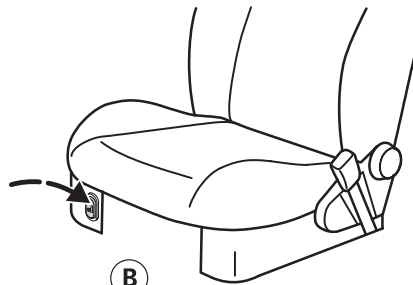

(B)

(A) Driver's seat

(B) Front passenger's seat



## Seating and safety restraints

The red mark on the side of the switch indicates that the heated seat is on.

The maximum temperature is reached after five or six minutes. It is regulated thermostatically.

When selected the heating will operate when the ignition switch is in position II.



Heating with the engine off will drain the battery.

### Head restraints

#### Front head restraints

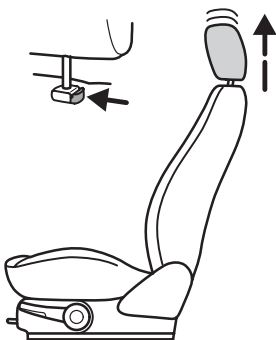

To adjust the height, pull the head restraint up or press the locking button and push the head restraint down.

Make sure that the head restraint engages properly when in position.

To remove, press the locking button and pull out the head restraint.

To replace, push the head restraint back into position.

#### Rear head restraints

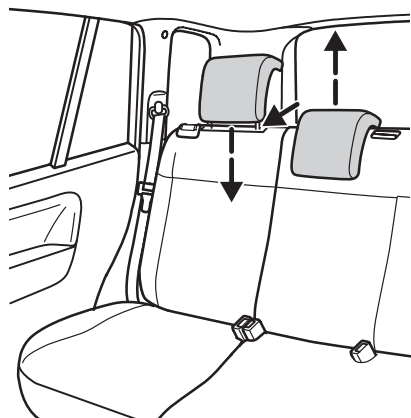

To raise, pull the head restraint up until it engages properly.

To lower, press the locking button and push the head restraint down.



Always have the rear head restraint raised when the rear seat is occupied by a passenger or a child restraint.

## Seating and safety restraints

### Folding the rear seatback forwards

Lower the rear head restraints.

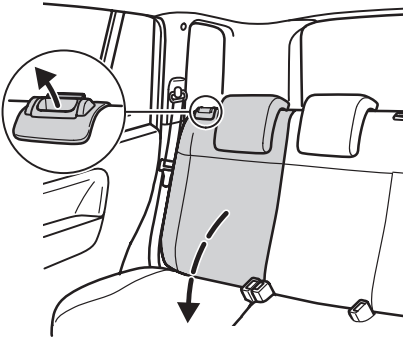

Pull the unlocking handle on the rear seatback and fold the rear seatback forwards.

### Returning the seatback to its upright position

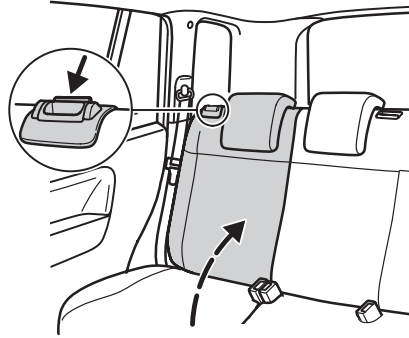

The seatback must engage in the latches.

**Note:** When the red marking in the unlocking mechanism is visible, the seatback is not fully engaged. Release the seatback and repeat the procedure until the red marking is no longer visible.

**Note:** If the seat belt integrated into the centre seatback does not function properly, check the unlocking mechanism.

The seat belts must be forward of the seatback.

## Seating and safety restraints

### Folding the seat cushion and seatback forwards

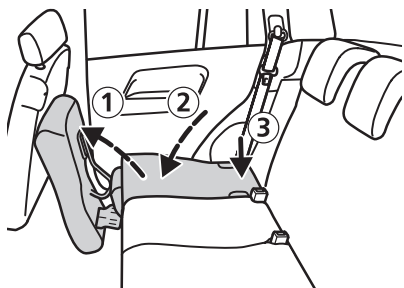

Slide the front seat forwards.

Fold the seat cushion forwards ①.

Lower the head restraints of the rear seats and fold the seatback forwards ② as described in the section *Folding the rear seatback forwards*, page 81.

Press the rear of the seatback down to create a level surface ③.

When returning the seats to their original positions, make sure the seat belts will function properly and are positioned in front of the seatback.

### SEAT BELTS



- Use seat belts at all times.
- Never use a seat belt for more than one person.
- Avoid wearing thick clothing.
- The seat belts should fit tightly around the body.

### Fastening the seat belts

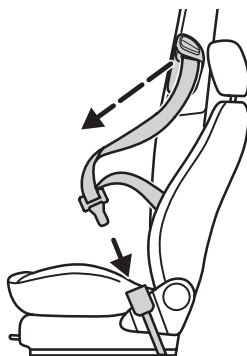

Pull the belt out steadily. It may lock if pulled sharply or if the vehicle is on a slope.



Insert the tongue into the buckle until a distinct click is heard, otherwise the seat belt will not be locked correctly.

## Seating and safety restraints

To release the belt, press the red button on the buckle and let the belt rewind completely and smoothly.

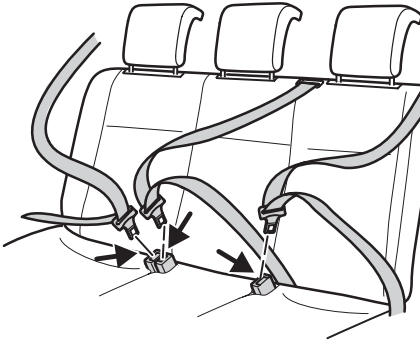

Make sure that each seat belt uses the correct buckle.

If your vehicle is equipped with a centre static belt:

To loosen, turn the tongue at right angles to the webbing and pull it. When fastening, ensure the tongue engages in the buckle with a positive click. To tighten, pull the loose end through the tongue ensuring the belt fits snugly across the hips in a low position.

### Adjusting the height of the front seat belts



Press the locking control on the height adjuster and move the pivot so that the belt rests across the centre of the shoulder.

## Seating and safety restraints

### **Pregnant women**

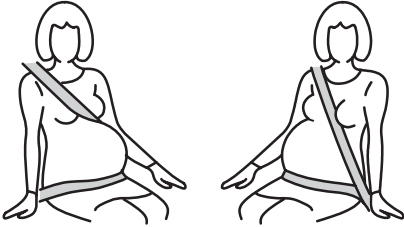

The lap strap should be fitted comfortably across the hips, low beneath the pregnant abdomen. The diagonal part of the seat belt should be placed between the breasts, and worn above and to the side of the pregnant abdomen.

Always wear seat belts without slack or twists. For optimum protection, the seat belts should fit tightly around the body. Do not recline the front seats excessively, as the belts provide maximum protection when the seats are in the near upright position.

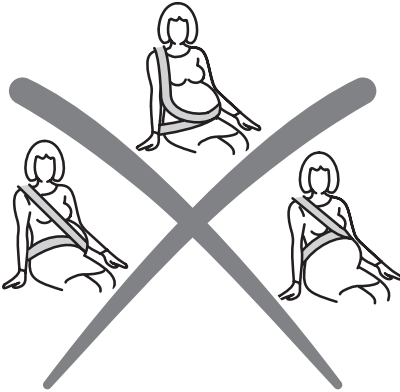

 Never wear just the lap strap of a lap/shoulder diagonal seat belt and never sit on the lap strap using just the shoulder strap. Both of these actions are extremely dangerous and may increase your risk of serious injury.

 Pregnant women must wear a correctly positioned seat belt; it is safer for mother and unborn child.

## Seating and safety restraints

### Seat belt pretensioner



The belt pretensioners must not be removed. If the pretensioners deployed during an accident, they must be replaced. Have the pretensioners serviced and disposed of by specially trained personnel only.

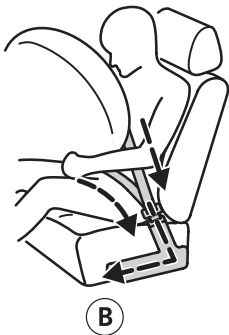
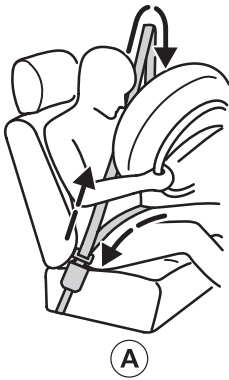

The restraint system, with belt pretensioner in the front seats, helps to reduce the risk of serious injury in a major frontal impact. During a serious crash the seat belts are pretensioned to help reduce slack in the belt. The safety belt pretensioner is a device which removes excess webbing from the safety belt system. When the safety belt pretensioner deploys, webbing from the lap and shoulder belt is tightened.

The belt pretensioner is not triggered in any side, rear or minor frontal collisions. For further details refer to section *Airbag*, page 87 onwards.

- Ⓐ Driver's seat
- Ⓑ Front passenger's seat

## Seating and safety restraints

### Care of seat belts

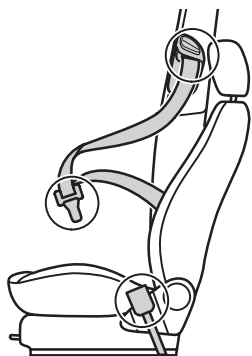

Periodically check the belts for damage or fraying.



Do not attempt to repair or lubricate retractor or buckle mechanisms or to modify the belts in any way.

Belts subjected to strain - as a result of an accident - should be renewed and the anchorages checked by an expert.

For information about cleaning the seat belts, please refer to section *Cleaning seat belts*, page 161.

## Seating and safety restraints

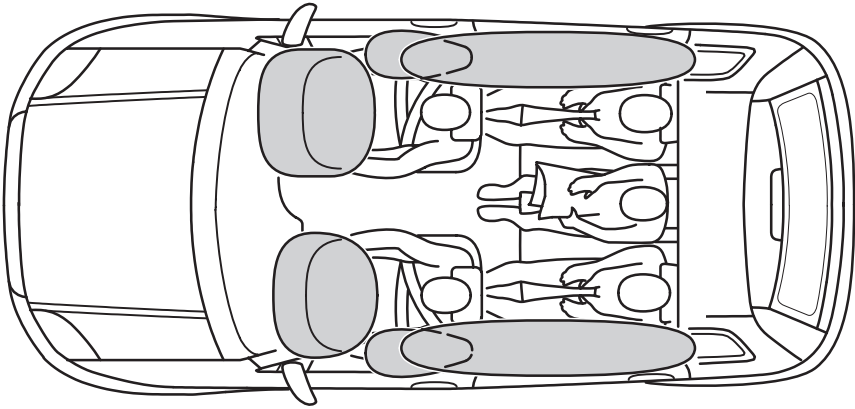

### AIRBAG

#### The system

The airbag system comprises the following:

- inflatable nylon bags (airbags) with gas generators
- side airbags
- curtain airbags
- seat belt pretensioners
- a number of crash sensors
- a warning light in the instrument panel
- an airbag deactivation switch (if equipped)
- an airbag deactivation light in the instrument panel (if equipped)
- an electronic control and diagnostic unit

**Note:** A loud bang will be heard when an airbag deploys and it is normal to see a cloud of harmless powdery residue.



## Seating and safety restraints

### Front airbags

The seat and back must be set correctly for the airbags to be optimally effective. Refer to section *Sitting in the correct position*, page 77.

This is the ideal seating position for the driver and front passenger and helps reduce the risk of injury from sitting too close to an inflating airbag.

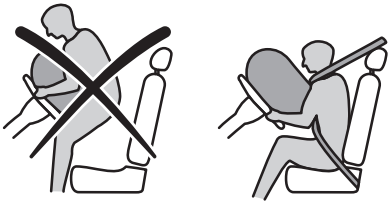

! Always wear the seat belt and keep sufficient distance between the driver and the steering wheel. Only when the seat belt is used properly, can it hold the body in a position which allows the airbag to achieve its optimum effect. There is a risk of injury when the airbag deploys.

! Do not modify the front of the vehicle in any way as this can adversely affect airbag deployment.

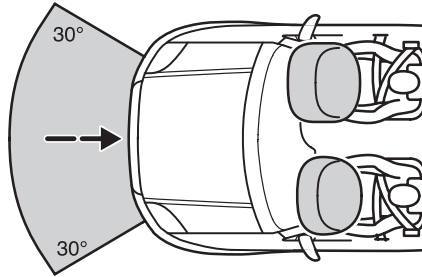

The front airbags activate during **major collisions** which are either **frontal** or **up to 30 degrees** from the left or the right. The airbags inflate within a few thousandths of a second. They will deflate on contact with the front occupants thus cushioning forward body movement.

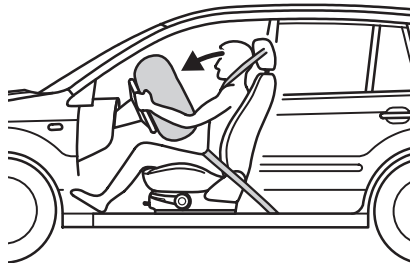

## Seating and safety restraints

**During minor collisions as well as overturns and rear or side collisions, the front airbag system will not be activated.**



Always keep the areas in front of the airbags free. Never affix anything to or over these areas.

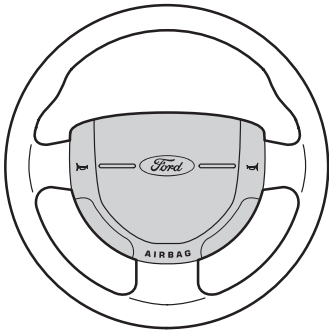

These areas should only be wiped with a damp cloth, never with a wet cloth.



Repairs to the steering wheel, steering column and airbag system should be carried out by properly trained technicians.

### Side airbags

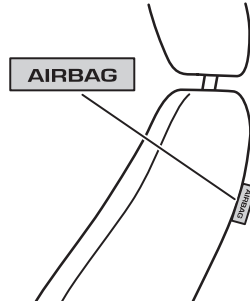

A label on the seatback indicates that side airbags are fitted.

The side airbags are fitted on the side of the seatbacks of the front seats. In case of a severe lateral collision, the airbag on the side affected by the collision will be inflated.

The airbag will inflate between the door panel and occupant. Once the occupant's body contacts the airbag, the propellant escapes, thereby cushioning the impact.

**The side airbags are not activated upon minor lateral collisions nor upon front or rear impacts.**

## Seating and safety restraints

### Front and rear curtain airbags

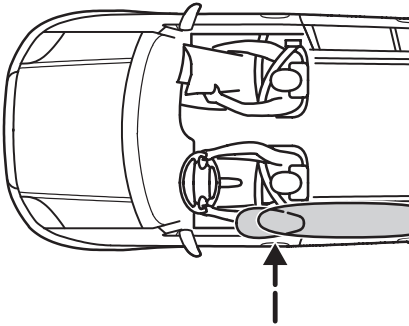



Moulded badges in the headlining over the side windows indicate that curtain airbags are fitted.

The curtain airbags are fitted over the front and rear side windows inside the roof lining.

In case of a severe lateral collision, the airbag on the side affected by the collision will be inflated.

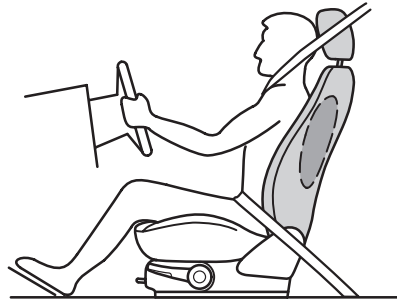
**The curtain airbags are not activated upon minor lateral collisions nor upon front or rear impacts.**



 Repairs to either of the front seat covers, the sensors attached to the seats as well as to the roof lining should only be carried out by properly trained technicians. Injuries may result if the side airbags are triggered inadvertently.

Do not block, obstruct or cover the airbag because it may prevent proper deployment.

Do not poke any sharp objects into the areas where airbags are fitted. This could damage the airbags.

Do not use any accessory seat covers that are not specifically designed for seats with side airbags. These seat covers must be fitted by properly trained technicians.

## Seating and safety restraints

### Airbag/seat belt pretensioner warning light



When the ignition switch is turned to position **II**, the warning light on the instrument panel illuminates for approximately 3 seconds to indicate that the system is functional.

If the warning light does not illuminate, if it stays on or illuminates intermittently or continuously while driving, it means there is a malfunction. Have the system checked by an expert.

### Passenger airbag deactivation

If individual circumstances require you to fit a child seat/restraint on a seat protected by an operational airbag in front of it, your vehicle is equipped to allow fitting of a passenger airbag deactivation switch operated by the ignition key.

Your Ford Dealer will be able to fit it.

The key switch will be fitted on the end of the instrument panel with an airbag deactivation light in the centre of the instrument panel.

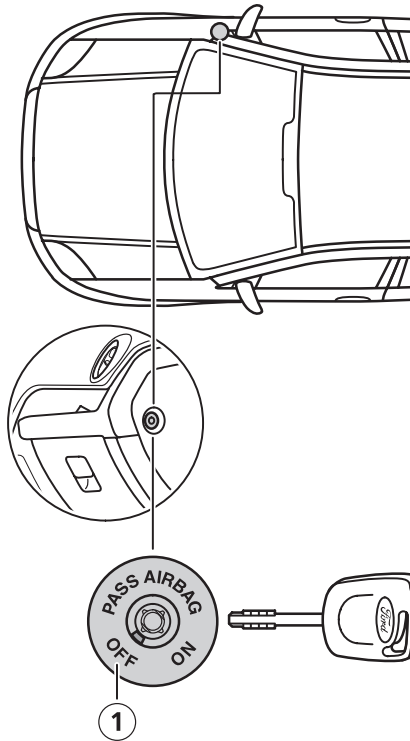

To use a rear facing child restraint in the front, make sure that the key switch is turned to the **OFF** position ①.

## Seating and safety restraints



 To avoid the risk of death or serious injury, **NEVER** use a rearward facing child restraint in the front, unless the airbag is **OFF**.

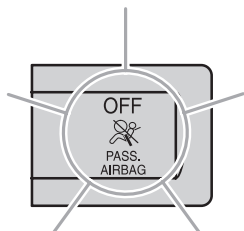

When the ignition is switched on (position II), check that the airbag deactivation light is illuminated.



If the instrument cluster airbag/seat belt pretensioner warning light illuminates intermittently, it means there is a malfunction. Remove the child restraint from the front.

Have the system checked by an expert for your own safety. Refer also to section *Airbag/seat belt pretensioner warning light*, page 91.

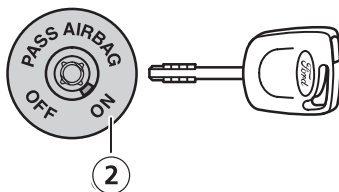

After removing the child restraint from the front, make sure that the key switch is turned to the **ON** position ②.

 To ensure the adult restraint system performs as intended, make sure the airbag is **ON**.

## Seating and safety restraints

### CHILD RESTRAINTS

Together with the adult seat belt, these restraints help provide maximum security for children.

Children of height 150 cm or under **or** 12 years or under should be secured in special restraints for children, such as baby seats, child safety seats or booster seats and cushions in the rear seat. Size and age limits for mandatory use of child restraints vary between individual countries.

Such equipment must be suitable and government approved (depending on country).



 Extreme Hazard! Do not use a rearward facing child restraint on a seat protected by an **operational** airbag in front of it!

There is a risk of death or serious injury when the airbag deploys.

Whenever installing a child seat/restraint, always read and follow the manufacturer's instructions.

 There is a risk of death or serious injury when the manufacturer's instructions are not followed properly or when the child restraint is modified in any way.

**Note:** If your vehicle is equipped with the airbag deactivation feature, please see the section *Passenger airbag deactivation*, page 91.

 Do not hold a child on your lap when the vehicle is moving.

A choice of ECE approved child restraints is available at your Ford Dealer. Please ask for the recommended child seats.

## Seating and safety restraints

### Placement of child restraints



If your Ford vehicle is equipped with a front passenger airbag, it is recommended that children of height 150 cm or under **or** aged 12 years and under should only be properly restrained in the rear seat. Rearward facing child restraints must **NEVER** be used in the front passenger seat protected by an **OPERATIONAL** front passenger airbag.

The following table advises on the suitability of child restraint fitment locations.

Child restraint positions					
Seating positions	Mass group categories				
	0	0+	I	II	III
	Up to 10 kg (about 0-9 months)	Up to 13 kg (about 0-18 months)	9 to 18 kg (about 9 months-4 years)	15 to 25 kg (about 3½-6 years)	22 to 36 kg (about 6-12 years)
	Baby safety seat		Child safety seat	Booster seat/cushion	
Front passenger airbag <b>ON</b>	<b>X</b>	<b>X</b>	<b>U<sup>1</sup></b>	<b>U<sup>1</sup></b>	<b>U<sup>1</sup></b>
Front passenger airbag <b>OFF</b>	<b>U</b>	<b>U</b>	<b>U</b>	<b>U</b>	<b>U</b>
Rear seats	<b>U</b>	<b>U</b>	<b>U</b>	<b>U</b>	<b>U</b>

**X** = Seat position not suitable for children in this mass/age group.

**U** = Seat position suitable for “universal” category restraints approved for use in this mass/age group.

**U<sup>1</sup>** = Seat position suitable for “universal” category restraints but Ford recommends that children should be secured in an appropriate child restraint **in the rear seats**.

To use a child restraint in the front, make sure that the passenger airbag deactivation key switch is turned to the **OFF** position (see page 91 onwards).

## Seating and safety restraints

 If completely unavoidable circumstances call for a child weighing more than 9 kg to travel in a front seat protected by an operational front airbag, always use a forward facing child restraint.

 Extreme Hazard! Do not use a rearward facing child restraint on a seat protected by an **operational** airbag in front of it!

 Always have the head restraint raised when a child restraint is being installed or occupying the seat, provided doing so does not move the child restraint away from the vehicle seat.

### **Child restraints for different mass groups**

The correct restraint to be used depends on the child's weight and age:

- **Baby safety seat**

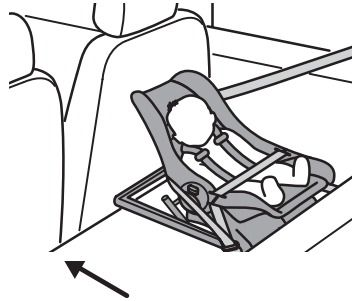

Babies under 13 kg (approximately 18 months) are best protected if properly restrained in rearward facing **baby safety seats** (Group 0+) in the rear seat.



## Seating and safety restraints

- **Child safety seat**



Children weighing between 13 and 18 kg (approximately eighteen months to four years old) should be carried properly restrained in **child safety seats** (Group I) in the rear seat.

- **Booster seat/booster cushion**

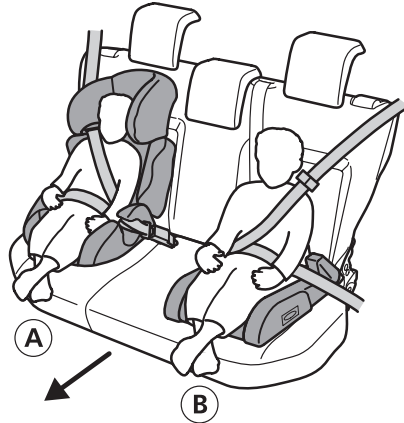

- Ⓐ Booster seat
- Ⓑ Booster cushion

Children weighing more than 15 kg and under 150 cm should use a **booster seat** or **booster cushion**. Ford recommends using **booster seats** that combine a booster cushion and a back rest into one seat for children between 15 kg and 25 kg. The raised seating position ensures that the adult seat belt can be correctly guided over the centre of the shoulder instead of along the neck, the lap belt lying tightly across the hips instead of the stomach. Make sure that your child sits in an upright position.

## Seating and safety restraints

### Note:

- If the vehicle has been involved in an accident, have the child safety seat checked by an expert as it might be damaged.
- When the child seat is not in use but inside the vehicle, secure it with the seat belt.
- Do not leave children unattended in the child safety seat or in the vehicle.
- When installing a child seat/restraint with the seat belt, always ensure belts fit without slack or twists.



You should never use a booster seat or cushion with only a lap belt.

Never put the shoulder belt under a child's arm or behind the back.

Never use pillows, books, or towels to boost a child.

# Driving

## BRAKES

### Dual circuit braking system

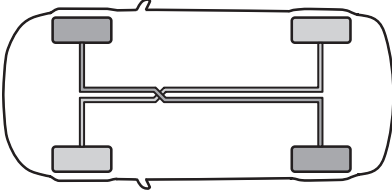

Your vehicle is equipped with a diagonally split dual circuit braking system. If one of the brake circuits fails, the other remains operative.



If a brake circuit fails, you will at first experience a softer feel to the brake pedal. You will then need to exert a greater force on the brake pedal, and make allowance for increased stopping distances. Have the braking system checked by an expert before continuing your journey.

### Disc brakes

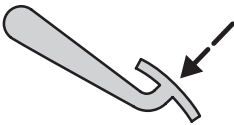

Wet brake discs result in reduced braking efficiency.

After leaving a carwash or driving the vehicle through water, dab the brake pedal while driving to remove the film of water.

### Brake system warning



The Brake system warning light remains illuminated when the handbrake is engaged.



If it illuminates after releasing the handbrake or when driving, have the braking system checked by an expert immediately.

**LOW BRAKE  
FLUID LEVEL**

In addition, on vehicles with a Message Centre, this message will appear in the display and the display warning light illuminates red.

See also section *Warning/information messages*, page 26 onwards.

### Anti-lock Braking System (ABS)

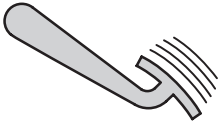

The ABS operates only when the wheels are about to lock. Its operation is indicated by a pulsing of the brake pedal and full steering control is retained. **Do not release the pedal whilst braking.**



Although the ABS ensures optimum braking efficiency, stopping distances can vary greatly depending on the road surface and conditions. Use of the ABS cannot eliminate the dangers inherent in driving too close to the vehicle in front of you, aquaplaning, excessive cornering speed or poor road surfaces.

### ABS warning light



If the ABS warning light illuminates when driving, it indicates a malfunction. Have this checked by an expert.

Normal braking (without ABS) will be maintained.

### Brake system and ABS warning lights



If **both** warning lights illuminate at the same time when driving, **stop the vehicle** as soon as it is safe to do so. Have the braking system checked by an expert before continuing your journey.



Reduce vehicle speed gradually. Use the brakes with great care. Do not step on the brake pedal abruptly.

In addition, on vehicles with a Message Centre, the warning message will appear in the display and the display warning light illuminates red.

See also sections *Brake system warning*, page 98, and *Warning/information messages*, page 26 onwards.

## Driving

### Emergency Brake Assist (depending on model variant)

The Emergency Brake Assist is able to detect an emergency braking situation by measuring the rate at which the brake pedal is applied. It automatically provides maximum braking efficiency as long as the pedal is applied. This can reduce stopping distances in critical situations.



The Emergency Brake Assist is an additional system which is not intended to relieve the driver of his responsibility for exercising due care and attention when driving.

### Hazards on heavy braking feature (depending on country)

At a vehicle speed of 96 km/h or more and if the brakes are applied abruptly (e. g. in case of an emergency braking), the hazard lights will automatically flash for a minimum of three times.

When the vehicle moves off again or if the hazard flasher switch is pressed, the hazard lights are switched off. The function is available again, when the vehicle's speed reaches 96 km/h or more.

To activate/deactivate this feature, see section *Settings menu*, page 31 onwards.

### Handbrake

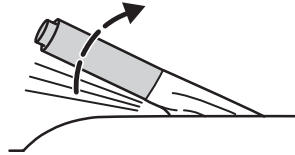

- Press the foot brake pedal firmly.
- Pull the handbrake lever up smartly to its fullest extent.
- Do not press the release button while pulling the lever up.
- If your vehicle is parked on a hill and facing uphill, select first gear and turn the steering wheel away from the kerb.
- If your vehicle is parked on a hill and facing downhill, select reverse gear and turn the steering wheel towards the kerb.



Vehicles with an automatic transmission should always be left with the selector lever in position **P**.

To release the handbrake, press the brake pedal firmly, pull the lever up slightly, depress the release button and push the lever down.

## ELECTRONIC STABILITY PROGRAM (ESP)

 Drivers should never take unnecessary risks even though the ESP system offers inherently safer driving potential.

### Principle of operation

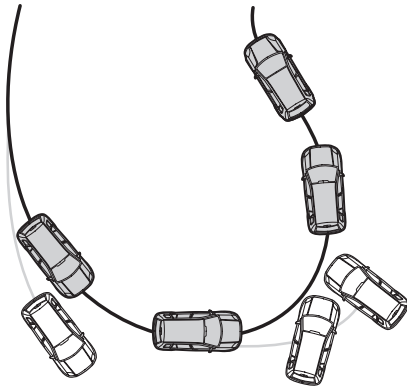

with ESP



without ESP

The ESP system provides an enhanced traction control function by reducing wheel spin at the driven wheels when accelerating. This improves the ability to pull away on slippery roads or loose surfaces.

The system also supports stability by counteracting the tendency of the vehicle to swerve away from the intended path. This is performed by braking individual wheels and/or reducing engine torque as needed.



When the ignition is switched on (position **II**), the ESP indicator light illuminates briefly to confirm that the system is operational.

Whilst driving, the light flashes during periods of activation.

 When the ESP indicator light is flashing the driver should take care and adapt their driving to the current conditions.

**Note:** If the indicator light does not illuminate when the ignition is switched on or if it stays illuminated whilst driving, it indicates a malfunction. Have the system checked by an expert.

## Driving

### Switching off the ESP

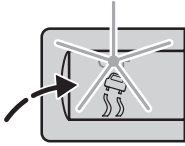

The system can be switched off manually by pressing and holding the ESP switch **for at least one second**. When the system is switched off, the ESP indicator light in the instrument cluster will illuminate. The system can be re-enabled by pressing and holding the switch again.

Each time the ignition is switched on, the system is automatically selected.

### STEERING COLUMN LOCK/ IGNITION SWITCH

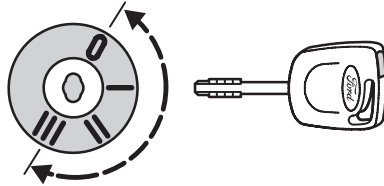

#### 0 Ignition off.

When the key is removed from the ignition switch, the steering column lock is activated as soon as the steering wheel is turned.

On vehicles with automatic transmission, the ignition key can be returned to position **0** and removed only if the selector lever is in the park position **P**.

**I** Steering unlocked. Ignition and all main electrical circuits are disabled.

The ignition key should not be left in this position for too long to avoid discharging the battery.

**II** Ignition switched on, all electrical circuits operational. Warning and indicator lights illuminate. This is the key position when driving and must also be selected when being towed.

**III** Starter motor activated. Release the key as soon as the engine starts.



Never return the key to the **0** position when the vehicle is in motion.

## GENERAL POINTS ON STARTING

The starter will not operate for longer than 30 seconds during each start cycle. Release the ignition key as soon as the engine has started.

If the engine has not started, return the ignition key to position **0** and repeat the starting procedure.



If the engine does not start, refer to the instructions regarding the fuel injection system shut-off switch on page 139.

## Engine speed limiter

The engine speed is limited electronically to protect the engine.

## STARTING THE ENGINE

### Vehicles with a petrol engine

#### *Cold/hot engine*

- Depress the clutch pedal fully and start the engine without touching the accelerator.



At temperatures below -20 °C, turn the ignition key to position **II** for at least one second before starting the engine. This ensures that maximum fuel pressure is established.

- If the engine does not start within 15 seconds, wait for a short period and repeat the procedure.
- If the engine does not start after **three** attempts, wait 10 seconds and follow the *Flooded engine* procedure.
- If starting difficulty is experienced at temperatures below -25 °C, depress the accelerator pedal 1/4 to 1/2 of its travel to assist starting.

#### *Flooded engine*

- Depress the clutch pedal fully.
- Slowly depress the accelerator **fully**, hold it in this position and start the engine.
- If the engine does not start repeat the *Cold/hot engine* procedure.



## Driving

### Vehicles with a diesel engine

If the vehicle run out of fuel, see section *Diesel low fuel safety mode*, page 124.

### Cold/hot engine

- Depress the clutch pedal without touching the accelerator.
- Turn the key to position II.



- If the Glow plug indicator light illuminates, wait until it extinguishes before starting.
- Continue cranking without pausing until the engine starts.
- If the engine stalls, repeat the full starting procedure.
- At temperatures below -15 °C it may be necessary to operate the starter for up to 30 seconds. If these weather conditions persist, an engine block heater is recommended.

### Switching off the engine

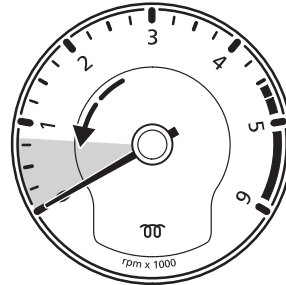

Wait until the engine has reached idle speed, then switch off.

Never depress the accelerator pedal.

If the engine is switched off at high speed, the turbocharger will continue running after the engine oil pressure has dropped to zero. This will lead to premature turbocharger bearing wear.

## Vehicles with automatic transmission

The engine can be started only with the selector lever in position **P**. If necessary, it can also be started with the lever in position **N**.

SELECT N OR P  
TO START

In addition, on vehicles with a Message Centre, this message will appear in the display and the display warning light illuminates amber.

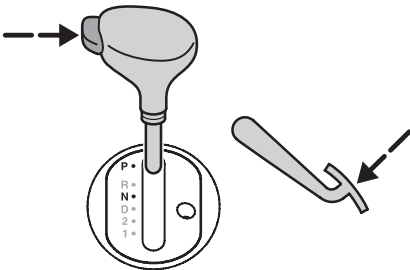

After starting the engine, the lever can be moved out of position **P** only when the **foot brake is depressed** and the **release button is pressed**.

See also section *Automatic transmission*, page 107 onwards.

## Vehicles with Durashift EST

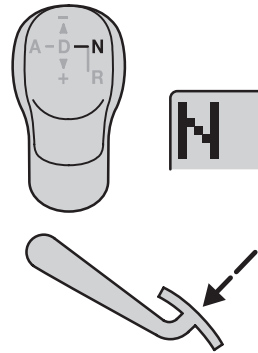

The engine can be started only when the lever position is in **N** and the footbrake has been depressed. The display will show **N**. If the footbrake is not pressed **N** will flash.

SELECT NEUTRAL

In addition, this message will appear in the display of the Message Centre and the display warning light illuminates amber.

If the vehicle is parked in gear the brake pedal should be pressed with the ignition switched on whilst moving the lever to neutral. This will release the gear.

## Driving

If the brake pedal is not pressed the gear will not be released, the display will flash and the vehicle will not start.

**PRESS BRAKE  
TO START**

In addition, this message will appear in the display of the Message Centre and the display warning light illuminates amber.

See also section *Durashift EST* from page 115 onwards.

## MANUAL TRANSMISSION

 Do not apply any undue lateral force to the gear lever when changing from 5th to 4th gear as this could lead to the inadvertent selection of 2nd gear.

 Engage reverse gear only when the vehicle is stationary.

To avoid shifting noises when engaging the reverse gear, wait approximately three seconds with the clutch depressed when the vehicle is stationary.

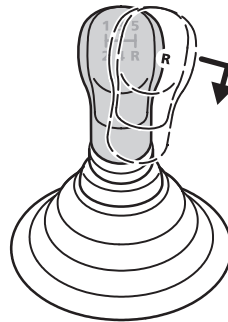

To select the reverse gear, shift the lever into the neutral position and then press the lever fully to the right against a spring pressure, before pulling rearwards until it engages.

## AUTOMATIC TRANSMISSION

The four-speed automatic transmission is electronically controlled.

### Selector lever

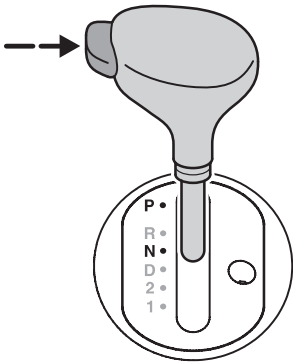

To disengage from **P**, make sure the ignition key is in position **II**, depress the brake pedal and press the release button on the side of the selector lever grip.

Press the release button to change from **N** to **R** or **P**, from **D** to **2** or **1** and from **R** to **P**.

### Selector lever positions

 Apply the handbrake or depress the footbrake before selecting a gear. Failure to do so could result in the vehicle pulling away when you have engaged a gear.

**Note:** A cold engine runs at a higher idling speed after starting. This can cause a strong 'creep' tendency in reverse and forward gears.

### Gear display



On vehicles with a Message Centre, the display in the instrument cluster shows the gear currently engaged (**P**, **R**, **N**, **D**, **2** or **1**).

## Driving

### **P = Park**

In this position, the transmission is locked.



This position should be selected only when the vehicle is stationary.



Whenever you leave the vehicle, make sure that the selector lever is securely latched in **P**, always apply the handbrake fully and turn off the ignition.



A warning signal will sound if the drivers door is opened when position **P** is not selected.

**DOOR OPEN  
NOT IN PARK**

In addition, on vehicles with a Message Centre, this message will appear in the display and the display warning light illuminates amber.

The battery saver deactivates this alarm 10 seconds after the key is turned to position **0**.

The key can be removed from the ignition lock only in position **P**.

Before the transmission reaches normal operating temperature, it runs in a special mode. See section *Cold mode* on page 112.

### **R = Reverse**

This position should be selected only when the vehicle is stationary and the engine is idling.

### **N = Neutral**

In this position, no power is transmitted to the drive wheels.



In this position, you have to depress the brake pedal or apply the handbrake to prevent the vehicle from moving.

### **D = Drive**



When stationary, this position should only be selected when the engine is idling.

This is the normal driving position.

When the brake pedal is released, the vehicle will creep. All forward gears are selected automatically depending on driving conditions.

## 2 = Gear 2

The automatic transmission remains permanently in 2nd gear.

This position should be selected on severe downhill gradients.

It can also be used to avoid frequent shifting between 1st and 2nd gears in slow moving traffic or to help when moving off on slippery or icy surfaces.

For driving on long uphill gradients, see section *Uphill mode*, page 112.

## 1 = Gear 1

The automatic transmission remains permanently in 1st gear.

This position should be selected on extreme downhill gradients.

For driving on long uphill gradients, see section *Uphill mode*, page 112.

## Overdrive

The 4th gear is designed as an overdrive.

Switching off the overdrive can help to increase the engine braking effect for enhanced control when driving on downhill gradients or if the transmission is frequently shifting between 4th and 3rd gear.

With the overdrive switched off, the transmission will shift only between gears 1 – 3.

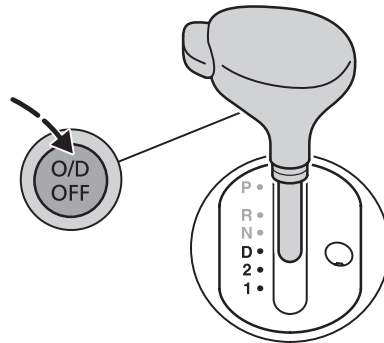

Depress the button located under the grip at the side of the selector lever to switch the overdrive off and on. The overdrive can be switched off and on while driving.

When the ignition is switched on again, overdrive is automatically switched on.

## Overdrive indicator light



The indicator light in the instrument cluster illuminates when the overdrive is switched off.

# Driving

## Driving with automatic transmission

### **Moving off**

With the engine idling and the brake pedal depressed, move the selector lever to one of the driving positions. Release the brakes. The vehicle will start to move slowly in the selected direction. Depress the accelerator pedal to increase speed.



When stationary, only move the selector lever to one of the driving positions when the engine is idling.

### • **Moving off in sand, mud or snow**

If the driving wheels are stuck, try to rock the vehicle free by driving forwards and backwards. To do this, move the selector lever alternately to **D** and **R** and depress the accelerator as little as possible.

To increase the effect, move the selector lever to **R** while the vehicle is still moving forward and vice versa.

To avoid excessive wear on the transmission when shifting between forward and reverse (rocking) keep the engine speed as low as possible.

Selecting position **2** may assist driving-off on icy or snowy road surfaces.

## Manual gear changes

### • **Moving off**

Select position **1**, release the handbrake and depress the accelerator pedal. Move the selector lever to position **2** and **D** as the road speed increases.

### • **Changing down**

If the transmission is in 4th gear and the overdrive is switched off the transmission will change down to 3rd gear if the vehicle speed is below 165 km/h. See also section *Overdrive*, page 109.

If the selector lever is moved from position **D** to position **2** while driving, the automatic transmission will change down to 2nd gear if the vehicle speed is below 85 km/h and will then remain in this gear. If the selector lever is moved to position **1** while driving, the transmission will change down to 1st gear if the vehicle speed is below 45 km/h and will then remain in this gear.

### **Stopping**

Release the accelerator pedal and depress the footbrake. Leave the selector lever where it is. To move off again release the footbrake.

Select position **N** if stationary for longer periods of time.

## Emergency park position release lever

This enables the selector lever to be moved out of the park position **P** in the event of a discharged battery or electrical failure.

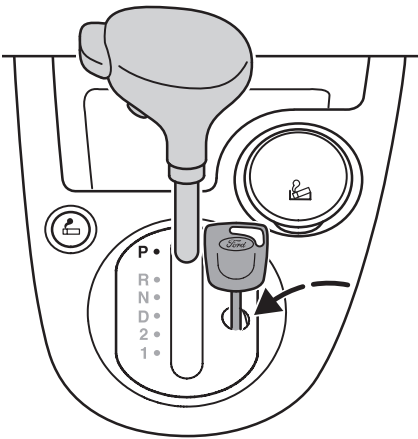

Remove the cover in the centre console next to the selector lever with a flat-bladed tool.:

With a suitable object push down the locking lever in the slot beneath the cover and simultaneously move the selector lever out of the **P** position.



If position **P** is selected again, this procedure must be repeated.

## Drive modes

### Downshift

When activated, this mode provides maximum vehicle performance when overtaking or, in conjunction with the Uphill mode, driving up steep gradients.

With the selector lever in position **D**, the transmission will select the appropriate gear according to the position of the accelerator pedal.

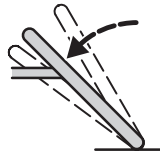

When the accelerator is pressed far enough, a resistance point can be felt. Maximum engine output is achieved when the pedal is held against this resistance point. The transmission selects the optimum gear for comfort and acceleration.

The transmission will change to the next higher gear before the engine speed approaches its upper limit.

The maximum possible acceleration may not be achieved. Use the Kickdown mode to achieve maximum acceleration.



## Driving

### **Kickdown**

When activated, this mode provides maximum possible acceleration when overtaking or, in conjunction with the Uphill mode, driving up steep gradients.

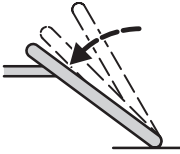

With the selector lever in position **D**, depress the accelerator pedal fully beyond its resistance point and hold it down.

The Kickdown mode is activated and the transmission will select the appropriate gear for maximum possible acceleration. In some situations, this gear may already be selected.

With the Kickdown mode activated, the transmission will not shift into the next higher gear until the engine speed approaches its upper limit.

Keep the pedal pressed fully beyond the resistance point to keep the Kickdown mode activated for as long as maximum acceleration is required.

The transmission will return to its normal operating mode as soon as the accelerator pedal is released and returns to any position before the resistance point.

### **Uphill mode**

Always use selector lever position **D** for driving on uphill gradients. The automatic transmission detects uphill gradients and automatically selects the most appropriate gear.

Avoid using selector lever positions **1** and **2** when driving on long uphill gradients as under some circumstances this can cause the transmission operating temperature to rise above normal limits and enter the Hot mode. See section *Hot mode*, page 113.

### **Downhill mode**

Supports your braking manoeuvre while driving downhill.

When appropriate, the transmission shifts down from 4th to 3rd gear to increase engine braking when the brakes are applied during downhill driving.

### **Cold mode**

In order to increase the transmission's efficiency and reduce wear and tear, 4th gear will not be selected until the transmission has reached normal operating temperature.

## Hot mode

When high transmission temperatures are detected, this mode is activated to help prevent damage to the transmission.



The Transmission/Engine systems fault warning light may illuminate while the Hot mode is activated.

**Note:** On vehicles without Message Centre, if this warning light illuminates, refer also to section *Transmission/Engine systems fault warning*, page 122.

TRANSMISSION  
HOT MODE

In addition, on vehicles with a Message Centre, this message will appear in the display and the display warning light illuminates amber.

The warning light and the message extinguish when the transmission has cooled down to normal operating temperature.

**Note:** Please follow the instructions in the table on page 114.

## Emergency mode

If a malfunction occurs in the transmission, this mode may be activated. This will result in unusual vehicle behaviour.



The Transmission/Engine systems fault warning light illuminates while the Emergency mode is activated.

**Note:** On vehicles without Message Centre, if this warning light illuminates, refer also to section *Transmission/Engine systems fault warning*, page 122.

TRANSMISSION  
MALFUNCTION

In addition, on vehicles with a Message Centre, this message will appear in the display and the display warning light illuminates red.

**Note:** Please follow the instructions in the table on page 114.

## Driving

What to do if the transmission warning light is on		
1	Stop the vehicle as soon as it is safe to do so.	
2	Select position <b>P</b> or <b>N</b> and let the engine idle for 10 minutes.	
3	Switch off the engine and restart the engine.	
4	Warning light is still <b>on</b> :	Warning light is <b>off</b> :
	<b>Switch off the engine.</b> Have the transmission checked by an expert <b>before</b> continuing your journey.	You can continue your journey. Have your vehicle checked by an expert at the earliest convenient time.

## DURASHIFT EST

The Durashift EST is an automated five-speed manual transmission. The clutch and the gear selection are operated automatically.

### Selector lever

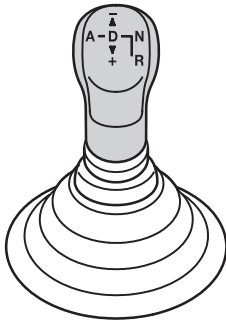

Gear selections are made by use of the gear selector lever.

## Creeping

 If **D** or **R** are engaged with the engine running and the footbrake is then released, on a flat surface the vehicle will slowly move off on its own (creep function).

A cold engine runs at a higher idling speed after starting causing an increase in creep speed (manual and **Auto** mode).

On a gradient the vehicle may **not** creep, depending on the steepness of the incline and the weight of the vehicle.

The creep function is turned off when the handbrake or footbrake is applied.

To protect the clutch from damage the creep will be disabled when the clutch temperature is too high.

 Never press accelerator and brake pedals simultaneously.

# Driving

## Gear display



The display in the instrument cluster shows the gear position currently selected.

**Auto** is displayed when automated mode is selected.



A flashing gear within the display indicates a requested gear. Driver action may be required. See also sections *Vehicles with Durashift EST*, page 115, *D = Drive*, page 117, and *Stopping*, page 120.

## Selector lever positions



Apply the handbrake or depress the footbrake before selecting a gear. Failure to do so could result in the vehicle pulling away when you have engaged a gear.

### N = Neutral

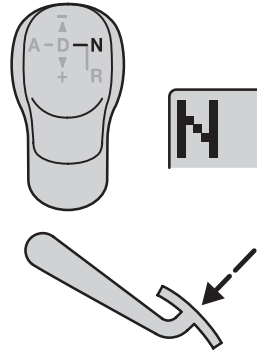

**Note:** In this position no gear is selected. To prevent the vehicle from moving you have to depress the footbrake or to apply the handbrake.

## R = Reverse



Select this position only when the vehicle is stationary and the engine is idling.

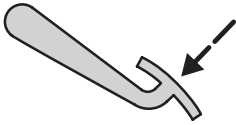
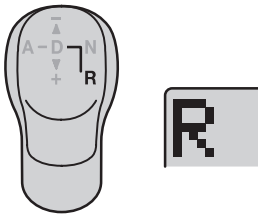

To shift into reverse gear, the footbrake needs to be depressed until reverse gear is engaged.

## D = Drive (automated mode)

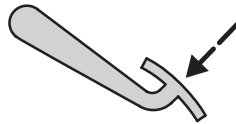
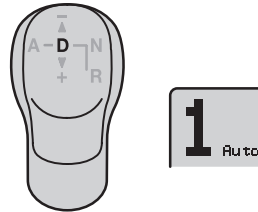

Depress the footbrake and move the selector lever from **N** to **D**. The transmission will be in automated mode and first gear will be engaged.

In this mode gear changes will be made automatically depending on driving conditions.

If the footbrake is not pressed when moving selector from **N** to **D** the display will flash. Return the selector to **N** and repeat the process with the footbrake depressed or press the accelerator directly.

## Driving

When in automated mode and selector positions **+**, **-** or **A** are used manual mode will be selected. The display will show the current engaged gear.

### **A = Mode change**

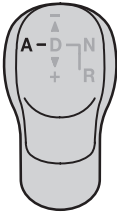

It is possible to change between automatic and manual mode at any time by pushing the shift lever to position **A** and releasing.

### **+/- = Manual mode**



Do not hold the shift lever permanently in **A**, **+** or **-**.

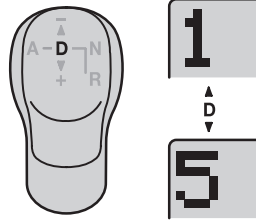

In manual mode the gears can be changed manually.

- +** Shifts to a higher gear
- Shifts to a lower gear.

Gears can be skipped by moving the selector repeatedly at short intervals.

**Note:** If a higher gear is requested when the speed is too low, or a lower gear when the speed is too high no shift will occur. This will prevent the engine from running at too high/low revolutions.

To avoid engine stall the transmission will automatically downshift when the vehicle speed is too low.

## Driving with Durashift EST

### Moving off

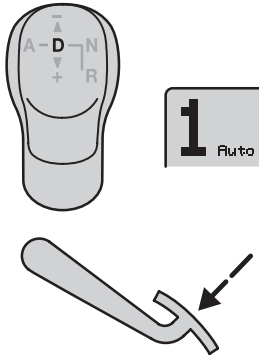

Depress the footbrake and move the selector lever from **N** to **D**. The transmission will be in automated mode and first gear will be engaged.

When the footbrake is released, on a flat surface the vehicle will creep. See also the sections *Creeping*, page 115, *Stopping*, page 120 and *Driving on inclines*, page 121.

Press the accelerator pedal to drive away.

### • *Moving away in sand, mud or snow*

If it becomes necessary to rock the vehicle to free it from snow, mud etc. move the selector lever between **D** and **R** repeatedly whilst applying light pressure to the accelerator pedal.



Do not race the engine and avoid sudden acceleration.

To protect the system the starting off aid is disabled at very high clutch temperatures.



On vehicles with a petrol engine and in manual mode the second gear can be selected by using **+** to improve pulling away in winter conditions etc..



# Driving

## **Downshift (Kickdown)** (Automated mode only)

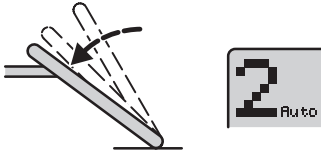

When the accelerator pedal is depressed beyond its resistance point the transmission will down-shift into a lower gear. This will make full use of the engine torque when overtaking or driving up steep gradients.

When the engine speed approaches its upper limit the transmission will shift into a higher gear.

## **Stopping**

 When stopping or waiting on a gradient always apply the handbrake. To prevent overheating of the clutch do not increase the engine revolutions.



When the selector is in the **D** position and the vehicle is at standstill, 1st gear will be engaged automatically.

Before exiting the vehicle with the engine still running place the selector in **N** and apply the handbrake.

**Note:** If the selector is moved to a gear, the engine is running and the driver's door is open, and no brake pedal pressed, a warning signal will sound and the gear display will flash.

DOOR OPEN  
APPLY BRAKE

In addition, this message will appear in the display of the Message Centre and the display warning light illuminates amber.

### **Parking with Durashift EST**



Before leaving the vehicle always apply the handbrake. If the engine is left running move the selector lever to **N**.

To park in gear the ignition should be on and the brake pedal depressed. The last gear engaged will be retained.

When the selector lever is in position **N** no gear will be retained and the vehicle is parked in Neutral.

When the ignition is switched off the transmission no longer responds to movement of the shift lever.

### **Driving on inclines**

#### **• Hill starts**

Do not hold the vehicle on a hill or against a kerb using accelerator pedal.

If the clutch becomes overheated a warning will be activated. The Transmission/Engine systems fault warning light illuminates (see also page 122) and the clutch will pulse. Normal operation will return when the clutch has cooled down.

#### **• Automated mode**

When driving, a higher gear will not be selected until a reasonably high engine speed has been achieved.

#### **• Manual mode**

To utilise engine braking select a lower gear when driving down hill.

### **Adaptive Shift Programmes**

Adaptive programmes automatically adapt gear shifting to suit the driving conditions such as if the vehicle is towing a caravan/trailer, has a high payload or is being driven on steep inclines.

## Driving

### WARNING LIGHTS AND MESSAGES

#### Transmission/Engine systems fault warning

A malfunction of the engine and powertrain related systems is indicated by the following:



1. The Transmission/Engine systems fault warning light **illuminates permanently** when driving.

The vehicle can still be driven. A minor reduction in performance may occur such as reduced power and/or acceleration.

Have your vehicle checked by an expert as soon as possible.

2. If the Transmission/Engine systems fault warning light **flashes** when driving, **stop the vehicle** as soon as safely possible and **switch off the engine** immediately.

Have the engine checked by an expert immediately.

#### ENGINE SYSTEM FAULT

In addition, on vehicles with a Message Centre, this message will appear in the display.

The display warning light illuminates **amber** (point 1) or **red** (point 2).

#### *Vehicles with Durashift EST*

#### TRANSMISSION MALFUNCTION

In addition this message may appear in the display and the display warning light illuminates red.

Refer to point 1.

#### *Vehicles with automatic transmission*

See also sections *Hot mode* and *Emergency mode*, page 113 onwards.

### Engine warning light



If the engine warning light illuminates with the engine running, it indicates a malfunction.

If the engine warning light **flashes** when driving, **reduce the vehicle speed immediately**. If it continues to flash, avoid heavy acceleration and high engine speed.

Have your vehicle checked by an expert immediately.

### Power steering failure

(vehicles with 1.6 l Duratorq-TDCi engine)



If the Power assisted steering warning light illuminates when driving, it indicates a malfunction of the power assisted steering system.

STEERING  
ASSIST FAILURE

In addition, on vehicles with a Message Centre, this message will appear in the display and the display warning light illuminates red.

Full steering will be maintained but you will need to exert greater force on the steering wheel.

Have the system checked by an expert as soon as possible.

## Driving

### Frost warning



At temperatures between +4 °C and +1 °C, the orange Frost warning light illuminates. At temperatures below +1 °C, the warning light glows red.

LOW OUTSIDE  
TEMPERATURE

In addition, on vehicles with a Message Centre, this message will appear in the display and the display warning light illuminates.

A warning chime will sound in the following conditions:

+4 °C or lower: frost warning (if all chimes are activated only, see also section *Chimes*, page 34)

The display warning light illuminates amber.

0 °C or lower: danger of icy roads  
The display warning light illuminates red.

See also section *Warning/information messages*, page 26 onwards.



Even if the temperature rises to above +4 °C there is no guarantee that the road is free of hazards caused by inclement weather.

### REFUELLING

#### Low fuel level warning light



If the fuel level is about 15 % of the tank capacity or below, the Low fuel level warning light illuminates. Refuel as soon as possible. Please refer also to section *Fuel gauge*, page 19.

In addition, on vehicles with a Message Centre, a warning chime will sound at the following ranges (if all chimes are activated only, see also section *Chimes*, page 34): 80 km, 40 km, 20 km and 0 km. Refer also to section *Distance to empty*, page 25.

#### **Diesel low fuel safety mode**

In the case that the vehicle runs out of fuel:

- Switch off the ignition.
- Fill up the fuel tank with a minimum of 7 litres.
- Turn the key to position II for 3 seconds.
- Start the engine.

For further information, see also the section *Diesel low fuel safety mode* on page 9.

### Fuel filler flap

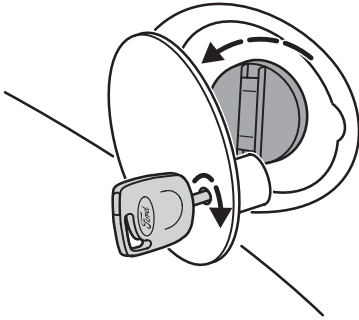

To unlock the filler flap, turn the key clockwise and open. Turn the cap anticlockwise and remove.

When the filler cap is removed, a hissing noise may be heard. This is normal and should be disregarded.

To close, turn the cap clockwise until it engages.

### Filling up

Refer also to the section *Fuel*, page 172.

 To avoid fuel spillage that could be hazardous to other road users, always stop refuelling after the fuel nozzle stops the second time. Additional fuel will fill the expansion space in the fuel tank which could lead to fuel overflowing.

 The fuel system is under pressure. There is a risk of injury if the fuel system is leaking. Do not use any kind of flames or heat near the fuel system.

### **Incorrect fuel**

 If you fill your vehicle with incorrect fuel or additives, **do not attempt to start the engine**. This may lead to engine damage.

## Driving

### DRIVING WITH A CATALYTIC CONVERTER

- Avoid running out of fuel.
- Avoid unnecessarily long engine cranking periods.
- Do not run the engine with a disconnected spark plug.
- Do not push-start or tow-start the vehicle; use jump leads.
- Never switch off the ignition while driving.

### Parking



It is important to avoid parking, idling or operating the vehicle on dry leaves or dry grass. Even when the engine is switched off, the exhaust will continue to radiate a considerable amount of heat for a short period creating a potential fire hazard.

### VEHICLE LOADING

#### Transporting luggage

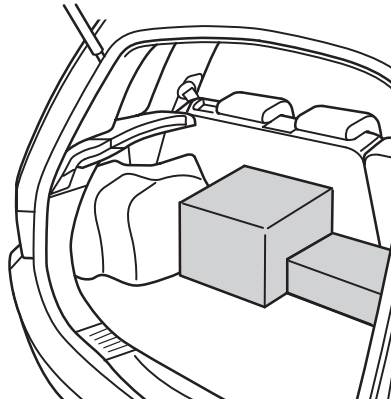

Luggage and other loads should be placed as low and as far forward as possible within the luggage compartment. Driving with the tailgate/rear door open is potentially dangerous as exhaust fumes may be drawn into the vehicle's interior.

## Driving

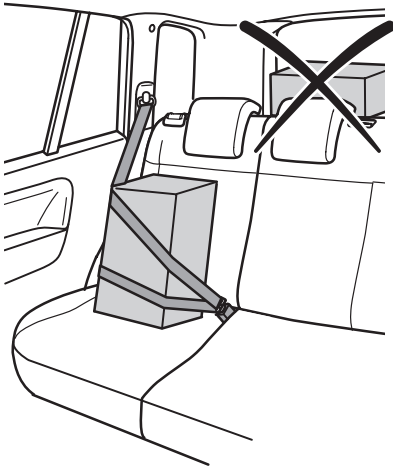

 If objects have to be placed in the vehicle, secure them from moving.

### Luggage cover



Do not place objects on the luggage cover.

### Removal

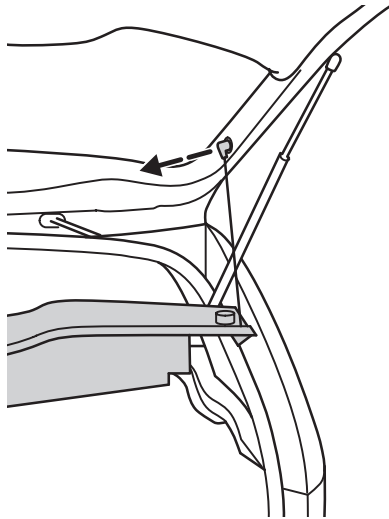

Detach the two lifting straps on the tailgate. Release the cover at its sides and pull it out horizontally without tilting it.

### Refitting

Insert the cover horizontally, align it and push in as far as the stop. Attach the lifting straps to the tailgate.



# Driving

## Luggage net

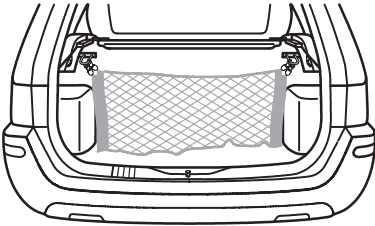

In order to secure light objects, a luggage net can be fastened to both sides of the trim in the luggage compartment.

## STORAGE AREAS

### Front storage compartment

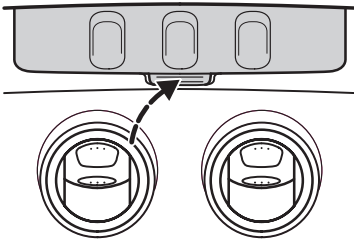

Press the button to open.

To close, push the cover down until it engages.

**Note:** Avoid keeping heat-sensitive objects in the front storage compartment.

 Never drive with the front storage compartment lid open. This will obscure your vision out of the front screen. Before setting off, always ensure that the lid is securely engaged.

### Storage area passenger side

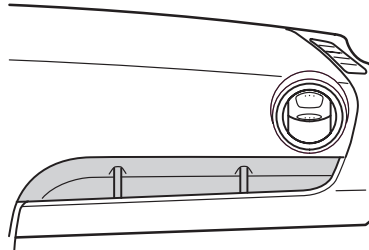

### Storage compartment

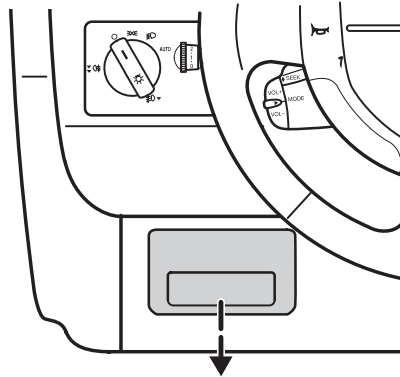

A storage compartment is provided underneath the instrument panel on the drivers side.

## Glove compartment

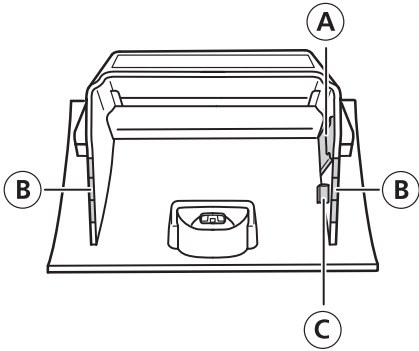

- Ⓐ Card holder
- Ⓑ Coin holders
- Ⓒ Pen/pencil clip

## Under-seat storage

The storage box is located under the front passenger seat.

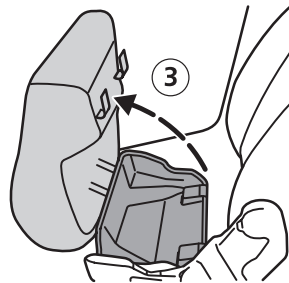
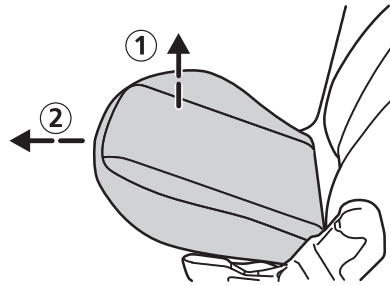

- To open: Pull the front of the seat cushion up ①.
- Pull the seat cushion towards the instrument panel ②.
- Lift the seat cushion to reveal the storage area ③.
- To close, follow the above steps in reverse, making sure that you push the seat cushion downwards until it locks into place.

# Driving

## Map pockets

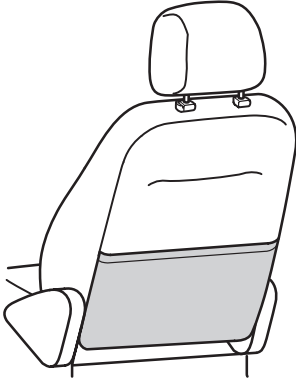

The map pockets are located on the rear of the front seatbacks.

## Coin holder

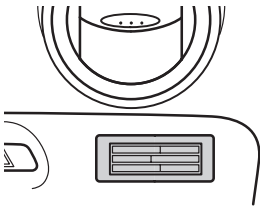

Depending on model variant coin holders are provided on the instrument panel.

## Storage pockets (depending on model variant)

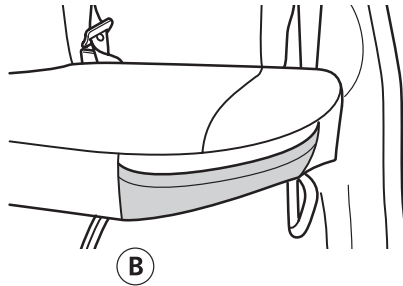
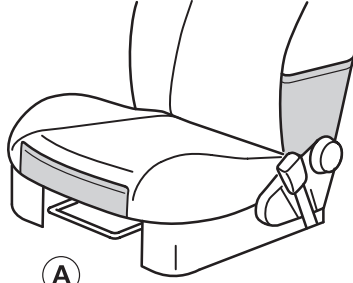

- Ⓐ Driver's seat
- Ⓑ Rear seats

### Installing the activity console (depending on model variant)

The activity console can be installed in the centre of the rear seat after removing the seat cushion.

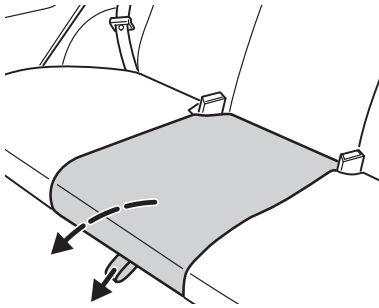

To remove the seat cushion, pull the loop at the bottom front edge and take it out.

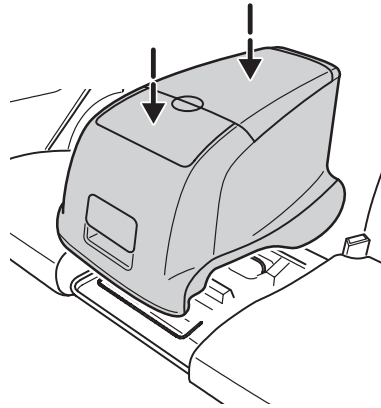

Gently press the console down until a distinct click is heard.

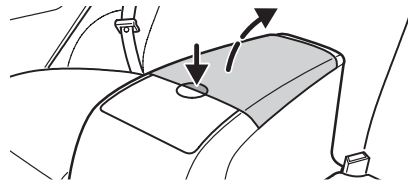

Press the rear half of the button to open the storage compartment.

## Driving

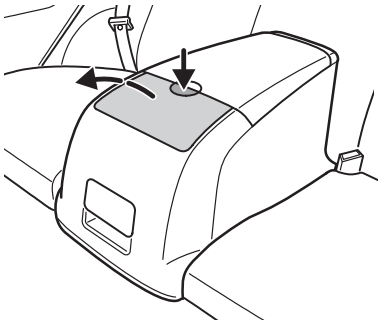

Press on the front half of the button to open the cupholders.

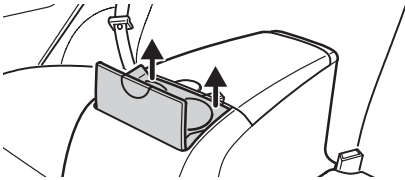

The cup holders can be removed to provide additional storage capacity.

 To avoid scalding, never place hot drinks in the cup holders while driving.

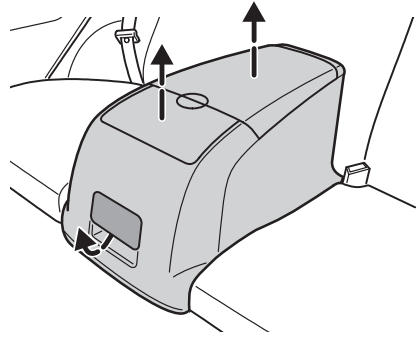

To remove the console, gently pull the front handle and take it out.

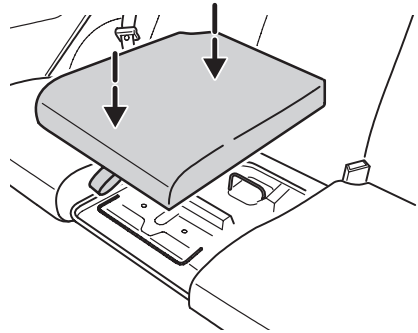

To reinstall the cushion, press it down until it engages in its catch.

 Ensure that the cushion is engaged properly and the loop is not caught.

### TRAILER TOWING

 If your vehicle has a detachable towball arm, remove and reinstall it regularly to keep the locking mechanism working smoothly.

The maximum vehicle and trailer payloads represent technically binding values for gradients up to 12 % and an altitude of 1 000 metres above sea level.

In high altitude regions, thinner atmosphere can reduce engine performance so the following restrictions will apply:

Above 1 000 metres, the stipulated maximum permitted gross train weight must be reduced by 10 % for every 1 000 metres in altitude.

### Steep gradients

Change down in plenty of time before downhill gradients.

If you have automatic transmission, according to the gradient, switch off the overdrive or select position **2** or **1** when going down steep hills.

For going up steep hills, refer to the section *Uphill mode*, page 112.

 The overrun brake on a trailer is not controlled by the anti-lock braking system.

### Detachable towball arm

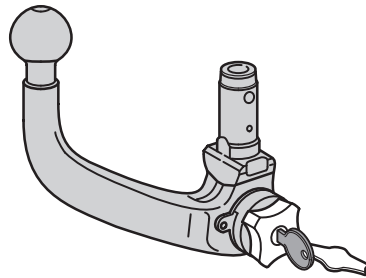
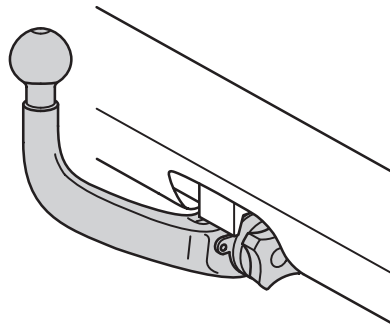

 **Always** remove the towball arm when it is not in use.

 The towball arm must be stored securely in the luggage compartment at all times when detached.

## Driving

### Unlocking the towball arm mechanism

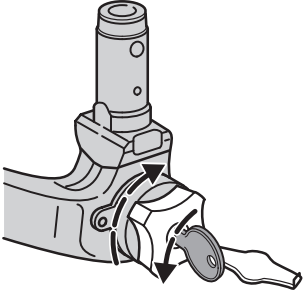

- Remove the protecting cap. Insert the key and turn anticlockwise to unlock.
- Hold the towball arm. Pull the handwheel out and turn it clockwise until it clicks.
- The red mark on the handwheel must align with the white mark on the towball.
- Release the handwheel. The towball arm is unlocked.

 Do not use any tools for mounting/dismounting the towball arm. Do not modify the trailer coupling. Do not disassemble/repair the towball arm.

### Inserting the towball arm

 Special care should be taken when fitting the towball arm, as the safety of the vehicle and the trailer depends on this.

 The towball arm may be inserted only when completely unlocked.

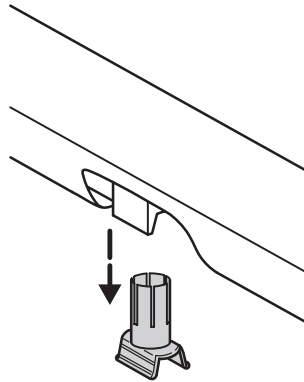

- Pull out the plug of the towball arm's seat.

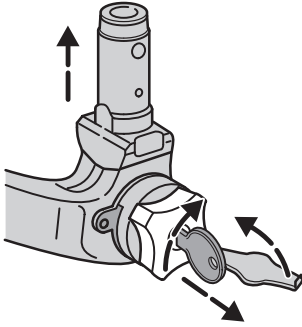

- Ensure that the towball arm handwheel is in the correct position with the red mark next to the white dot.
- Insert the towball arm vertically and push it up until the locking mechanism engages automatically. When the towball arm is engaged, the green mark on the handwheel will be next to the white dot.
- To lock: Turn the key clockwise.
- Pull out the key and insert the end of the protection cap into the keyhole.

### **Driving with a trailer**

Before starting your journey, ensure the towball arm is properly locked. Check:

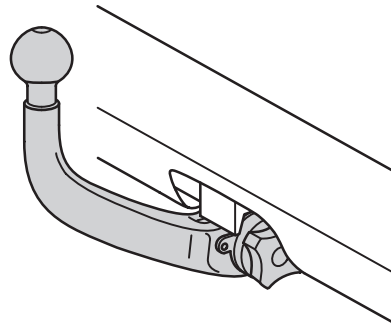

- The green mark on the handwheel has to be next to the white dot on the towball arm.
- The key has been removed.
- Secure positioning of the towball arm. (Must remain perfectly in place when jerked.)
- Attach the safety cable to the safety cable eye.



Never attach the safety cable directly to the towball arm.



If any of the above conditions cannot be met, do not use the tow bar and have it inspected by an expert.



## Driving

### Removing the towball arm

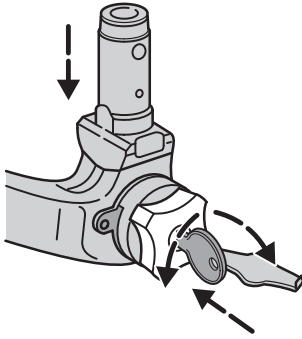

- Remove the protection cap covering the keyhole.
- Insert the key and turn it anti-clockwise to unlock. The arrow on the key points to the unlock symbol on the handwheel.
- Pull out the handwheel and turn it clockwise until the red mark is next to the white dot.
- Pull the towball arm downwards to remove.
- Insert the plug into its seat after removing the towball arm.



To avoid risk of injury, never unlock the towball arm with the trailer attached.

### Maintenance

Keep the system clean. Periodically lubricate the lock with graphite.



Remove the towball arm and protect the seat with the plug before steam cleaning your vehicle.

Keep a note of the key number.

### ROOF RACK



Driving with a roof load can have a negative influence on the driveability of the vehicle.



When driving with a roof load, the ESP system (if equipped) **must** always be switched on.



If the vehicle is used with a roof load, or is fully laden, the tyres **must** be set to standard tyre pressure setting.

### ULTRASONIC PARK DISTANCE SENSOR

 The park distance sensor is an auxiliary system which is not intended to relieve the driver of his responsibility for exercising due care and attention when reversing. In particular, some objects close to the vehicle (approx. 30 cm) and above or below the sensors may not be detected by the park distance sensor and cause damage to the vehicle. Ultrasonic waves, heavy rain and/or conditions causing disruptive reflections may lead to objects not being detected by the sensors. In addition, objects which absorb ultrasonic waves may not always be detected due to their unfavourable surface characteristics.

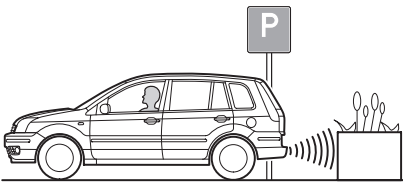

The system is activated automatically after the ignition is switched on and the reverse gear is selected. A short tone will sound to indicate system readiness.

A system failure will be indicated by a deep continuous tone or by a deep tone sounding in three-second intervals. In both cases the system is not reliable.

Have the system checked by an expert.

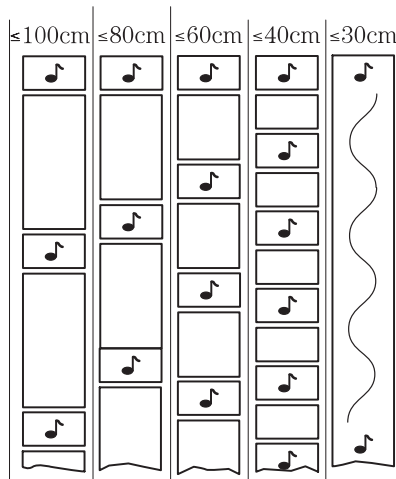
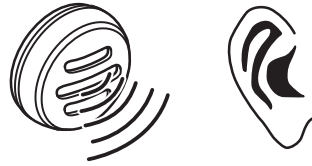

The measuring range is divided into five warning zones. As the distance to an obstacle reduces, a warning sounds, beginning as a slow bleep and increasing to a continuous tone.

Always keep the sensors free from dirt, ice and snow (do not clean with sharp objects).

## Roadside emergencies

### HAZARD FLASHER SWITCH



Press the switch to turn on or off. The hazard flasher switch does not flash. The hazard lights can be operated when the ignition is off.

### FIRST AID KIT AND WARNING TRIANGLE

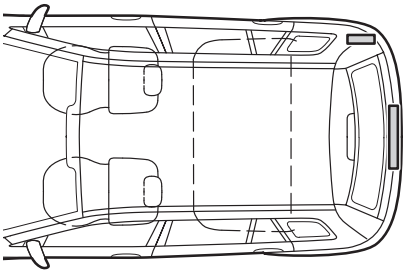

A retaining strap on the right-hand side of the luggage compartment can be used to secure a first aid kit box.

A retaining strap on the rear panel of the luggage compartment can be used to secure a warning triangle.

### LIMITED OPERATION STRATEGY PROGRAMME

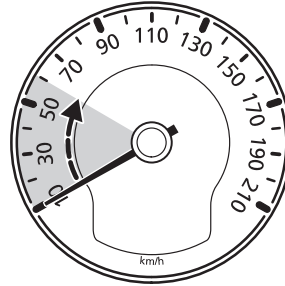

The engine management system incorporates a Limited Operation Strategy programme. If a fault occurs in the system, the engine will still function but performance may be reduced.

The vehicle can be driven at road speeds of up to 60 km/h on level surfaces.



Have the vehicle checked by an expert immediately.

## Roadside emergencies

### FUEL INJECTION SYSTEM SHUT-OFF SWITCH (vehicles with petrol engine)

The fuel supply may be cut off as a result of an accident or sudden vibrations (e.g. collision when parking).

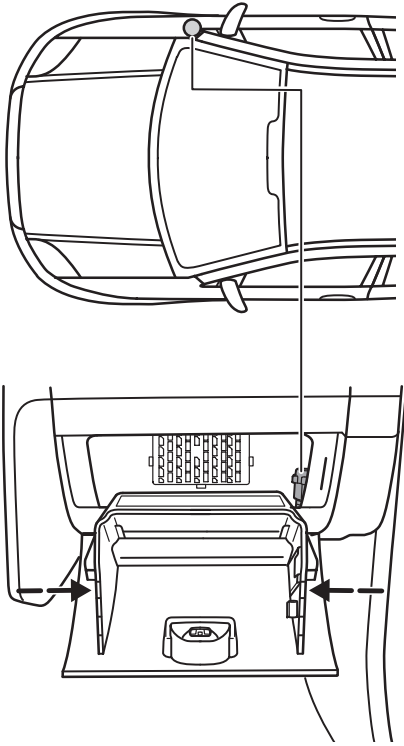

The switch is located behind the glove compartment.

Open the glove compartment and empty it before continuing. Press the side parts of the glove compartment inwards and swivel the compartment further down.

The button under the yellow cap will be raised when the switch is activated.

### Resetting the switch



Do not reset the fuel pump shut-off switch if you see or smell leaking fuel.

- Turn the ignition switch to position **0**.
- Check the fuel system for leaks.

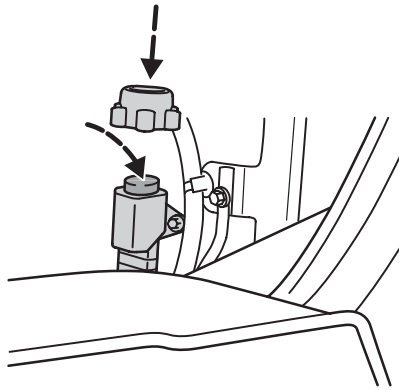

- If no fuel leak is apparent, reset the switch by pushing in the button.
- Turn the ignition switch to position **II**. After a few seconds return the key to position **I**.
- Make a further check for leaks in the fuel system.

# Roadside emergencies

## FUSES

 Switch off the ignition and all the electrical equipment before changing a fuse.

Always replace a faulty fuse with a new one of the same rating.

 Any improper alterations to the electrical or fuel system can endanger the safety of the vehicle as they could constitute a fire hazard or cause engine damage. Have any work involving these systems or the replacement of relays or high current carrying fuses carried out by an expert.

### Central fuse box

The central fuse box is located behind the glove compartment in the instrument panel.

To gain access to the fuse box:

- Open the glove compartment and empty it before continuing.

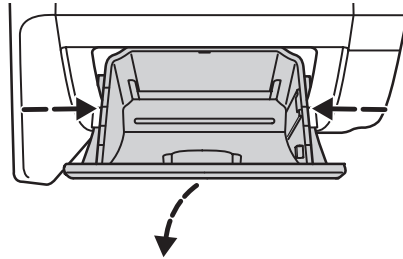

- Press the side parts of the glove compartment inwards and swivel the compartment further down.

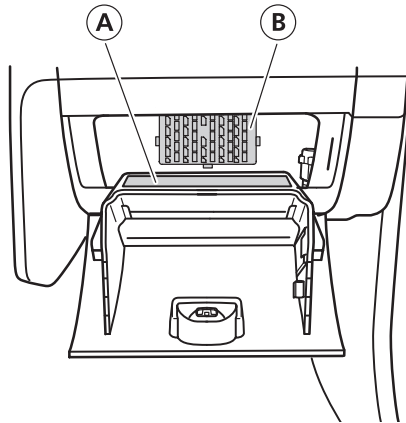

**(A)** Fuse chart label

**(B)** Fuses

- Reinstall in the reverse order.

## Roadside emergencies

### Fuse chart label

The fuse chart label shows rectangles representing a fuse. The following information is shown in the rectangles:

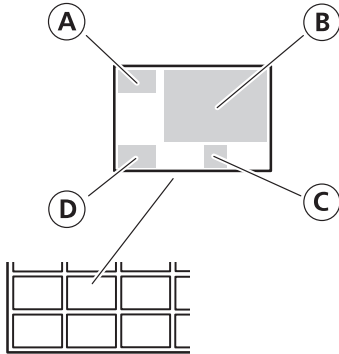















- Ⓐ Number of the fuse (**F**).
- Ⓑ Symbol of the function, see table on the following page.
- Ⓒ **L** = left-hand side, **R** = right-hand side.
- Ⓓ Ampere rating of the fuse.

### Symbols in the fuse boxes







Symbol	Definition
	See Owner's Handbook
	Airbag
	ABS
	Dipped beam
	Main beam
	Fog lights
	Light switch
	Front wiper





## Roadside emergencies

Symbol	Definition
	Rear wiper
	Heated front screen
	Heated rear screen
	Heated mirror
	Electrically operated outside rear-view mirrors
	Front power windows
	Electrically operated sunroof (not used)
	Heated seats

Symbol	Definition
	Heater blower
<b>A/C</b>	Air conditioning
	Cigar lighter
	Horn
	Daytime running light (Scandinavia only)
	Automatic transmission/ Durashift EST
	Engine management (Diesel only) or catalytic converter
<b>START</b>	Starter motor

## Roadside emergencies

Symbol	Definition
<b>AUDIO</b>	Audio, diagnostic plug
	Engine management or electronic module
	Fuel pump
	Auxiliary heater/ Diesel glow plug/ Injector pump relay/ Fuel fired heater
	Battery, alternator
	Instrument cluster, battery saver, number plate light, generic electronic module
	Side and tail lights
	Central locking, alarm horn

Symbol	Definition
	Hazard flasher, direction indicator
<b>IGN</b>	Ignition
	Trailer towing module
<b>AUTO</b> 	Durashift EST
<b>STOP</b>	Brake light
	Reversing light





## Roadside emergencies

### BULB REPLACEMENT

Always switch off lights and ignition before replacing any bulb.

Never touch the glass of the bulbs. Fit only bulbs having a UV filter. Always replace a faulty bulb with a new one of the same type. After replacing a bulb, check that the lights operate correctly.

 Have the headlight alignment checked after each replacement of a bulb.

 During operation, the bulbs and their surroundings get hot. Switch off the lights and let the bulbs cool down before replacing them.

### Headlights, side lights, direction indicators

It is necessary to remove the light assembly to remove any of the bulbs.

### *Removing the light assembly*

1. Open the bonnet.

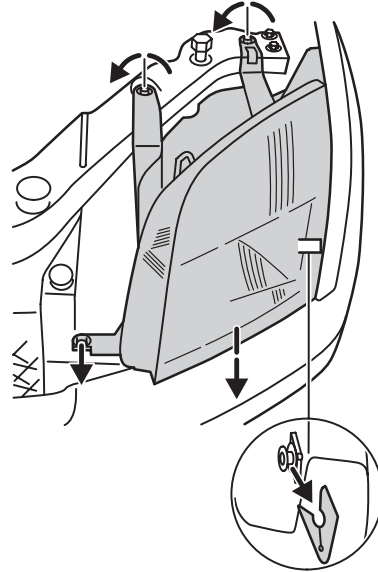

2. Remove the screws in the light assembly.
3. Carefully pull out the light assembly from the side and top clip and disconnect the wiring connector.

**Note:** When installing in the reverse order, first fix the hook/pin under the fender to get the right position for the other locator arms. Make sure that the side clip engages properly.

## Roadside emergencies

 When re-installing the light assembly, make sure that the wiring connector is engaged properly and that the wire harness is securely snapped into the clip-in feature on the rear of the light assembly.

### **Front direction indicator**

21 watt spherical bulb, orange

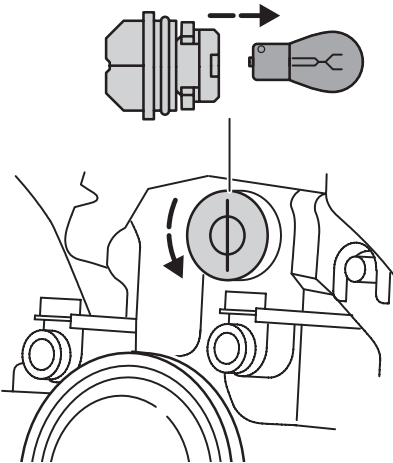

1. Turn the bulb holder anticlockwise and pull out.
2. Turn the bulb under slight pressure anticlockwise and remove it.
3. Replace the bulb.

When installing in the reverse order, pay attention to the guide tabs.

### **Opening the headlight assembly**

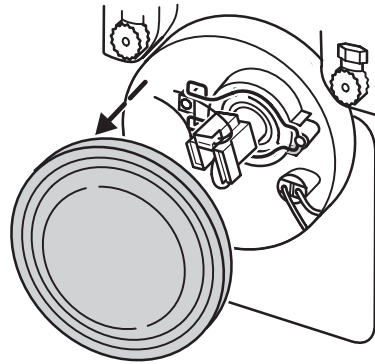

1. Remove the cover.

## Roadside emergencies

- **Headlights – main/dipped beam**

H4, 55/60 watt halogen bulb

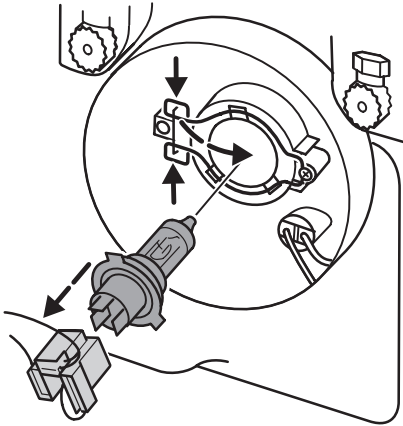

1. Pull off the wiring connector.
2. Disengage the wire clip and pull out the bulb.
3. Replace the bulb.

When installing in the reverse order, make sure the wire clip engages properly to bulb housing.

- **Side lights**

5 watt wedge base bulb

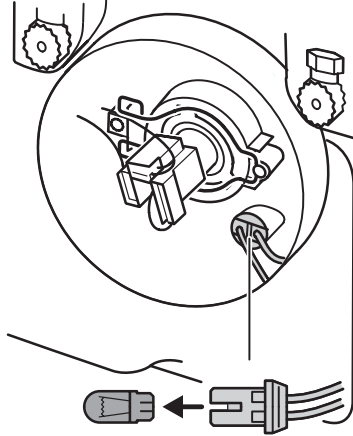

1. Carefully prise out the socket.
  2. Pull out the bulb and replace it.
- Install in the reverse order.

## Roadside emergencies

### Side repeater indicator

5 watt wedge base bulb

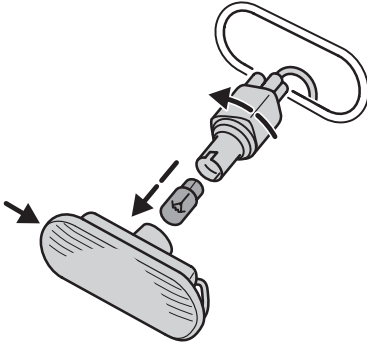

1. Carefully pull out the light assembly, complete with the bulb holder.
2. Grasp the bulb holder, turn the light housing anticlockwise and remove it.
3. Pull the bulb out and replace it. Install in the reverse order.

### Front fog lights

H11, 55 watt halogen bulb

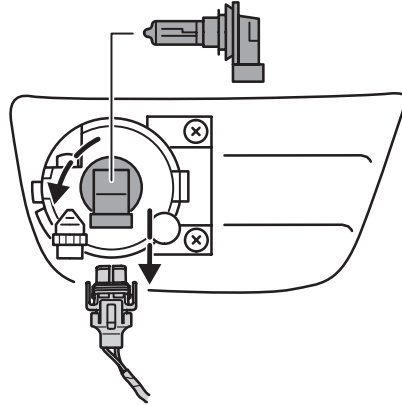

1. Reach behind the bumper and pull off the wiring connector.
2. Turn the bulb holder anticlockwise and pull it out.
3. Replace the bulb with the integrated bulb holder. Install in the reverse order.

## Roadside emergencies

### Rear lights

1. Open the tailgate.

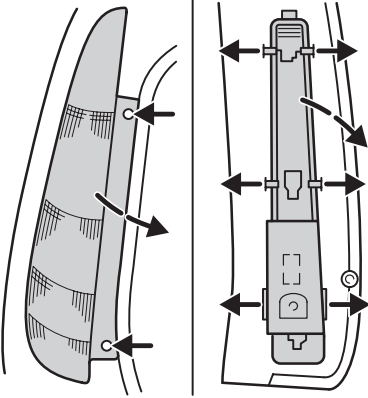

2. From inside the luggage compartment, lift the flap in the trim panel and remove the wing nut on the rear of the light assembly.
3. Remove the screws on the front of the rear light assembly and carefully pull it out.
4. Open the 6 clips and remove the entire bulb holder.

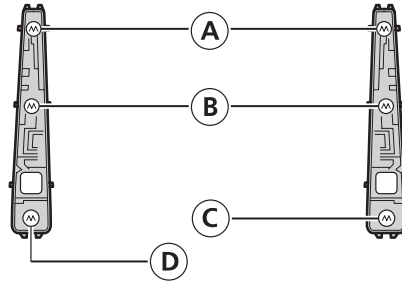

- Ⓐ Brake/tail light  
21/5 watt
- Ⓑ Direction indicator  
21 watt (orange bulb)
- Ⓒ Reversing light  
21 watt
- Ⓓ Rear fog light  
21 watt

5. Turn the bulb anticlockwise under slight pressure, and remove it.

6. Replace the bulb.

Install in the reverse order.

## Roadside emergencies

### High mounted central brake light

16 watt wedge base bulb

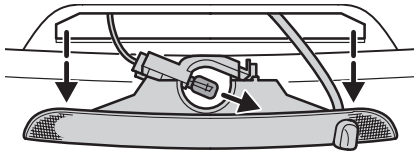

1. Open the tailgate and remove the rubber grommet.
  2. Depress the metal springs through the aperture using a flat-bladed screwdriver.
  3. Unclip the light assembly.
  4. Unclip the bulb holder from the light assembly.
  5. Pull the bulb out and replace it.
- Install in the reverse order.

### Number plate light

ZW5 watt festoon bulb

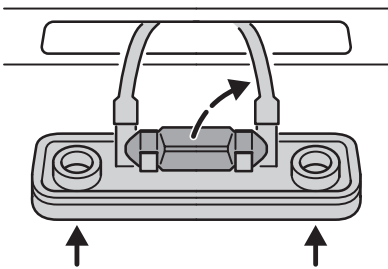

1. Loosen the screws, and remove the light assembly.
  2. Pull the bulb out and replace it.
- Install in the reverse order.

### Interior lights

10 watt festoon bulb

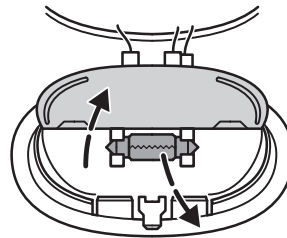
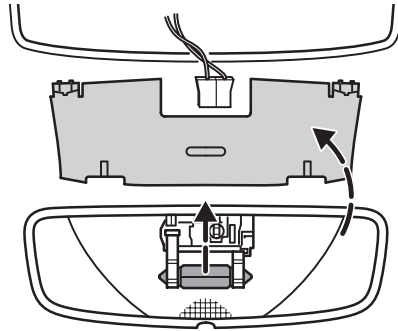

1. Switch off the interior lights (left switch position).
  2. Prise out the light assembly at the side opposite the switch with a flat-bladed screwdriver.
  3. Remove the reflector.
  4. Remove the bulb and replace it.
- Install in the reverse order.

## Roadside emergencies

### Reading lights

5 watt spherical bulb

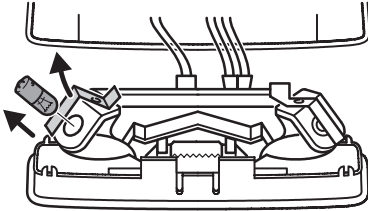

The bulbs can be replaced after the contact plate has been hinged back.

### Reading lights (depending on model variant)

5 watt wedge base bulb

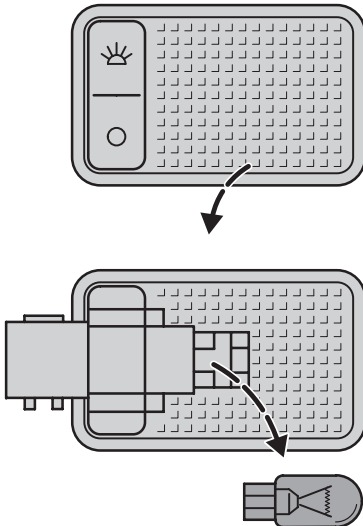

1. Carefully prise out the lens.
2. Replace the bulb.

### Luggage compartment light

5 watt wedge base bulb

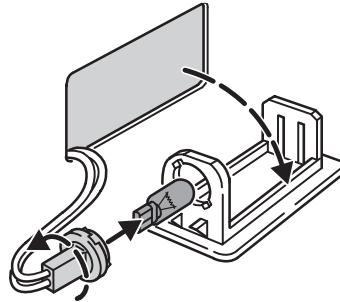

1. Carefully prise out the light assembly from the holder with a flat-bladed screwdriver.
  2. Remove the bulb and replace it.
- Install in the reverse order.

## Roadside emergencies

### CHANGING A WHEEL

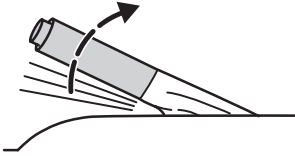

• Park your vehicle in such a position that neither the traffic nor you are hindered or endangered when changing a wheel.

- Set up a warning triangle.
- Ensure that the vehicle is on firm, level ground.
- If necessary, secure the vehicle with suitable chocks.
- Point the front wheels straight ahead.
- Switch off the ignition and apply the handbrake.
- Select first or reverse gear.

With Durashift EST, depress the footbrake and select the gear before switching off the ignition. If the vehicle has an automatic transmission, select the **P** position.



The vehicle jack must only be used to carry out wheel changes. Do not work under the vehicle when it is supported only by the jack.



If your vehicle is fitted with directional tyres, make sure that the arrows on the tyres point in the direction of rotation when the vehicle is moving forwards. The arrows on both tyre sidewalls indicate the direction of rotation.

If a spare wheel has to be fitted with the arrows pointing in the opposite direction to the direction of rotation, have the tyre remounted in the correct direction by an expert as soon as possible.

### Spare wheel



Use only approved wheel and tyre sizes. Using other sizes could damage the vehicle and will make the National Type Approval invalid.



If the spare wheel differs from the other fitted wheels, these rules must be followed:

- Do not exceed 80 km/h.
- Drive the shortest possible distances.
- Do not fit more than one spare wheel on your vehicle at any one time.



## Roadside emergencies

- Do not use snow chains on this type of wheel.
- Do not drive through an automatic car wash.
- Vehicles with Electronic Stability Program (ESP) may exhibit some unusual driving characteristics. Switch the ESP off. Refer to the section *Electronic Stability Program (ESP)*, page 101 onwards.
- If the spare wheel is used on the rear axle of vehicles with Durashift EST, the system may not be able to select a higher gear in automated mode (AUTO). This is due to the different size of the spare wheel and the standard wheel/tyre combination. Select manual mode to shift into a higher gear. After replacing the spare wheel with the standard wheel, normal operation in automated mode (AUTO) will return.



The vehicle may exhibit some unusual driving characteristics or engine overheating may occur if you use the spare wheel on the rear axle in automated mode (AUTO) for longer than a temporary period. Select manual mode to shift gears.

The spare wheel is located under the floor cover in the luggage compartment.

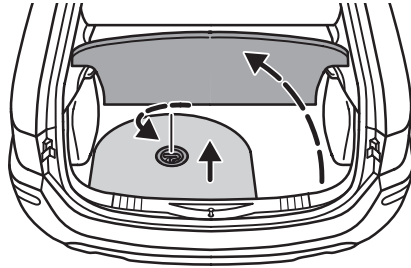

- Raise the rear of the floor cover in the luggage compartment and remove it.
- Completely unscrew the retaining device anticlockwise.

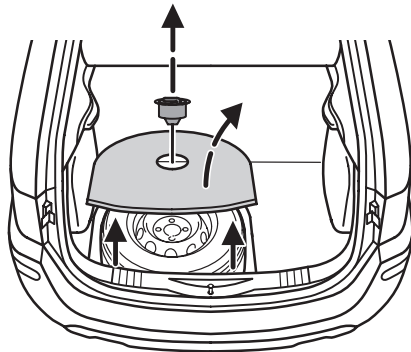

- Remove the spare wheel cover.
- Lift out the spare wheel.
- Install the defective wheel in the reverse order.

## Roadside emergencies

### Vehicle jack

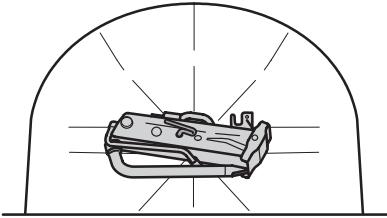

The jack and wheelbrace are located in the spare wheel well. Unscrew the retaining device by turning anticlockwise, and remove the jack with the wheelbrace.

Remove the clipped on towing eye.

**Note:** When reinstalling, use the left hole in the jack for the jack retaining device and the right hole for the spare wheel retaining device.

### Jacking points

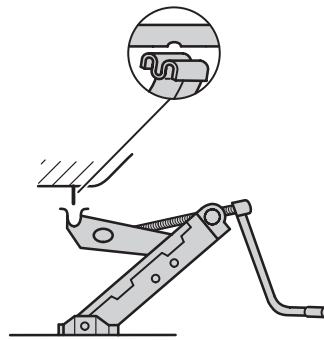
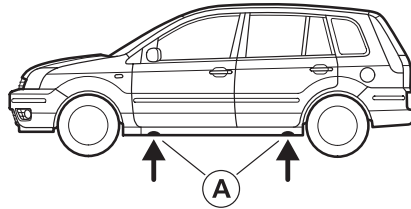

The jack must only be used on the small indentations **A** under the sills.

 The jack must be applied vertically to the jacking point.

## Roadside emergencies

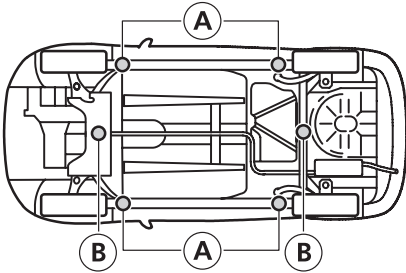

Points **(A)** can be used for trolley jacks, workshop hoists or jack stands. Points **(B)** can be used for trolley jacks in the centre, front or rear.

Positioning at other points may cause considerable damage to the body, steering, suspension, engine, braking system or fuel lines.

### Removing a wheel

- Make sure that the vehicle is on a flat surface and the front wheels are pointing straight ahead.
- Switch off the ignition and apply the handbrake.
- Select reverse or 1st gear.

With Durashift EST, depress the footbrake and select the gear before switching off the ignition.

If the vehicle has an automatic transmission select the **P** position.

- Have the passengers leave the vehicle.
- If necessary, secure the vehicle against rolling or sliding by using suitable wheel chocks.

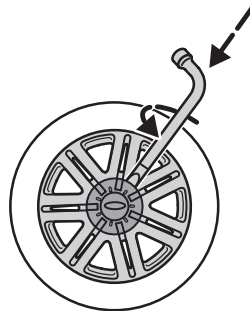

- Insert the flat end of the wheelbrace between the rim and the hub cover and twist carefully to remove the cover.

## Roadside emergencies

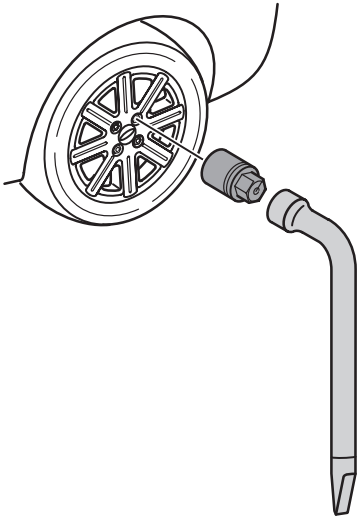

- Insert the nut key onto the locking nut (if equipped).
- Slacken the wheel nuts.
- Place the jack with the whole foot area on firm ground.
- Jack up the vehicle until the wheel is clear of the ground.
- If the whole foot area does not remain on the ground, lower the vehicle and reposition the jack.
- Unscrew and remove the wheel nuts and take off the wheel.

Replacement locks and wheel nuts can be obtained using the wheel nut reference number certificate (if equipped).

### Fitting a wheel



Alloy wheels must **never** be secured using wheel nuts for steel wheels.

- Push the wheel onto the wheel studs. Screw on the wheel nuts and secure in a clockwise direction ensuring that the tapered end of the wheel nuts is facing the wheel.

**Note:** The wheel nuts of alloy wheels can also be used for the steel spare wheel for a short time (maximum two weeks).

- Lower the vehicle and remove the jack.
- Insert the nut key onto the locking nut (if equipped).

## Roadside emergencies

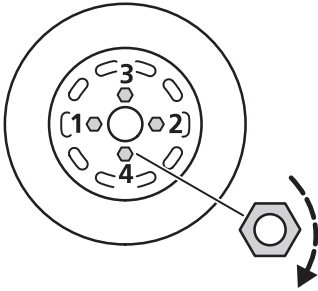

- Fully tighten the wheel nuts in the pattern shown.
- Press on the hub cap firmly with the ball of the hand.
- Stow the locking nut key in a safe place.
- Stow the jack and defective wheel in reverse order and secure them (see note on page 153).

Have the tightening torque of the wheel nuts and the tyre pressure checked as soon as possible.

### BATTERY

#### Maintenance

The battery requires very little maintenance. The fluid level is checked during the routine service inspections.

#### Ignition warning light



If it illuminates whilst driving, switch off all unnecessary electrical equipment and drive immediately to the nearest expert.

#### Removal and installation

If the battery has been disconnected the vehicle may exhibit some unusual driving characteristics for approximately 8 km after battery reconnection while the engine management system realigns itself with the engine.

The audio system must be reprogrammed with the keycode. Refer to the separate manual.

## Roadside emergencies

### JUMP STARTING

Connect batteries with only the same nominal voltage (12 volts). Use jump leads with insulated clamps and adequate size cable. Do not disconnect the battery from the vehicle's electrical system.

#### To connect the leads

- Position the vehicles so that they do not touch one another.
- Switch off the engine. Switch off electrical equipment.
- Connect the positive (+) terminal of the flat battery (A) to the positive (+) terminal of the booster battery (B).
- Connect one end of the second lead (2) to the negative (-) terminal of the booster battery (B).
- **Do not connect to the negative (-) terminal of the flat battery.**
- On **vehicles with a petrol engine**, connect the other end of lead (2) as far away from the battery as possible to the engine block or the engine mount of the engine to be started.
- On **vehicles with a diesel engine**, connect the other end of lead (2) to the turbo charger (3) of the engine to be started (as shown in the graphic).
- Make sure that the jump leads are clear of moving parts of the engine.

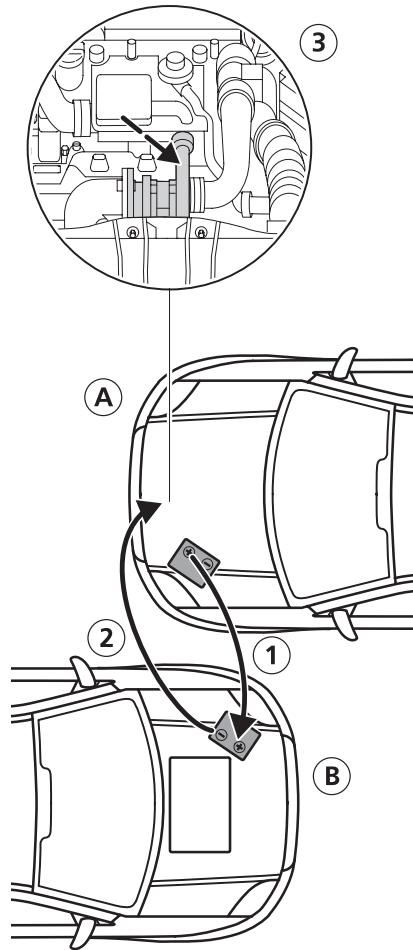

- (A) Flat battery
- (B) Booster battery

## Roadside emergencies

### To start the engine

- Run the engine of the vehicle with the booster battery at moderately high speed.
- Start the engine of the vehicle with the flat battery.
- Run both vehicles for a minimum of three minutes before disconnecting the leads.

 Do not switch on the headlights when disconnecting the leads. The peak voltage could blow the bulbs.

- Disconnect the leads in the reverse order.

### TOWING THE VEHICLE

The screw-in towing eye is attached to the jack in the luggage compartment.

The towing eye must **always** be carried in the vehicle.

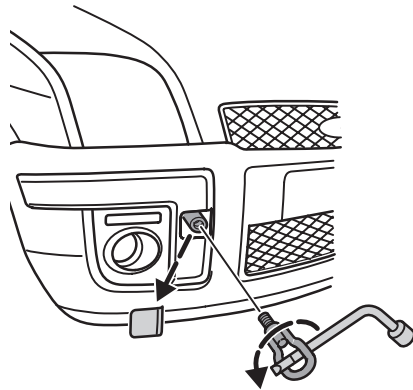

Press the lower part of the cover in the front bumper and prise it off. Install the towing eye.

 The screw-in towing eye has a **left-hand thread**. Install it by turning **anticlockwise**. Use the wheelbrace to ensure the towing eye is fully tightened.

After use, unscrew the towing eye and re-insert the cover.

## Roadside emergencies

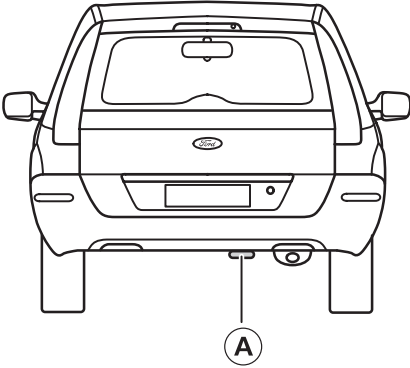

### Ⓐ Rear towing eye

Before using the rear towing eye, remove the cover. After use, reinstall the cover to its original position.

When towing always drive off slowly and smoothly without jerking the towing vehicle. Excessive tow rope tension could result in damage to either vehicle.

**Note:** Observe the safety regulations that are valid for towing a vehicle depending on country.

 The ignition key must be set to position **II** when the vehicle is being towed so that the steering, direction indicator lights and brake lights are fully operational. Since the brake servo and the power steering do not operate with the engine switched off, you will need to exert greater force to the brake pedal and steering wheel. Make allowances for the increased braking distance and heavier steering.

### Towing vehicles with Durashift EST



When a vehicle with Durashift EST is towed, **N** (Neutral) must be selected.



## Roadside emergencies

### Towing vehicles with automatic transmission

When a vehicle with an automatic transmission is towed, the selector lever must be in position **N** (neutral).

 Never tow a vehicle with an automatic transmission faster than 50 km/h or further than 50 kilometres.

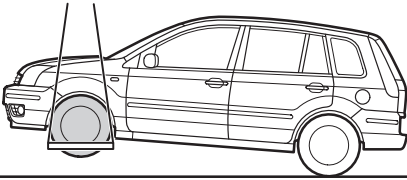

If it is necessary to tow the vehicle a greater distance, the drive wheels must be lifted clear off the ground.

 Never tow a vehicle backwards with the drive wheels turning. If this instruction is not adhered to, it could cause damage to the automatic transmission.

### Starting vehicles by towing or pushing

 To prevent damage you must **not** push- or tow-start your vehicle. Use jump leads and a booster battery.

## Cleaning

### WASHING YOUR VEHICLE

The best procedure is brushless washing in a good car wash installation.



In installations operating with high water pressure, water might be forced into the vehicle's interior or parts may get damaged.



Unscrew and remove the radio aerial before entering an automatic car wash. Switch off the heater blower to prevent contamination of the fresh air filter.

If a waxing cycle is selected, please ensure that the wax is removed from the front screen afterwards.

### Cleaning the headlights

To avoid damaging the clear plastic headlight lens do not use aggressive abrasives or chemical solvents. Do not wipe the lights when they are dry or use sharp objects to clean the lenses.

### Cleaning the rear screen

To avoid damaging the heating elements when cleaning the inside of the rear screen use only a soft cloth or a damp chamois leather. Do not use solvent or sharp objects to clean the glass.

### Cleaning seat belts

Use Interior Cleaner or clean warm water. Dry naturally, away from artificial heat.

Do not use chemical cleaners, boiling water, bleach, or dye. Do not allow moisture to penetrate the seat belt retractor mechanism.

## Cleaning

### PAINT CHIP REPAIR

Paint damage from road chippings or minor scratches can be repaired using aerosol paint spray or touch-up paint. The Ford Accessory range is recommended. Observe the application instruction on each product.



To retain vehicle warranty on paintwork, remove apparently harmless looking but often aggressive particles from the paintwork immediately - e.g. bird droppings, tree resins, insect remains, tar spots, road salt and industrial fall-out.

### BODY PAINTWORK PRESERVATION

Wax the body paintwork of your vehicle once or twice a year. This will help retain the glossy paintwork finish and water droplets will run off more easily.



When polishing your vehicle ensure that polish does not come into contact with the plastic surfaces as it may prove difficult to remove.

Do not polish the vehicle in strong sunshine.

Do not apply polish to front or rear screen, as this may result in poor or noisy wiper action.

# Maintenance

## SERVICING

- Check and top up fluid levels regularly.
- Check tyre pressure.
- Check brakes and lights are operating correctly.
- Check warning and indicator lights.



The electronic ignition system works with high voltage. Never touch these components with the engine running or the ignition switched on.



The ignition must be switched off before working in the engine compartment. Under some operating conditions, the cooling system fan may continue to run for several minutes after the engine has been switched off. This is quite normal. Take care not to get any fingers or clothing such as ties or scarves caught in the fan.

## Maintenance chart

Every day check:
<ul style="list-style-type: none"><li>• Operation of all exterior and interior lights and make sure that all lenses are clean.</li></ul>
When refuelling check:
<ul style="list-style-type: none"><li>• Engine oil level</li><li>• Brake fluid level</li><li>• Screen washer fluid level</li><li>• Tyre pressures and condition (only when cold)</li></ul>
Once a month check:
<ul style="list-style-type: none"><li>• Coolant level (engine cold)</li><li>• Assemblies, pipes, hoses and reservoirs for leaks</li><li>• Power steering fluid level</li><li>• Operation of air conditioning</li><li>• Operation of handbrake</li><li>• Operation of horn</li></ul>

**Note:** The air conditioning should be used for at least 30 minutes per month.

## Maintenance

### Opening the bonnet

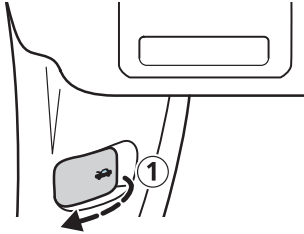

- Pull the bonnet release lever ① situated in the left-hand side footwell.

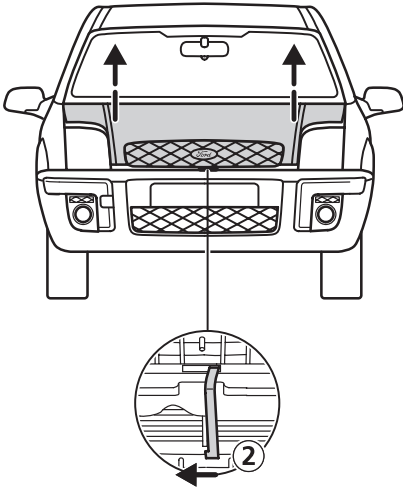

- Push the safety catch ② to the left to release it.

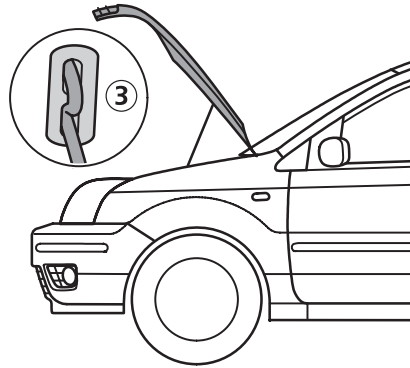

- Raise the bonnet fully and support its strut in the retainer ③ ensuring it is secure.

To close, lower the bonnet and allow it to drop into the catch for the last 30 cm.

Always check to ensure that the bonnet lock is fully engaged.

# Maintenance

## Engine compartment

Position	Description	See page
Ⓐ	Engine coolant reservoir <sup>1</sup>	169
Ⓑ	Engine oil filler cap <sup>1</sup>	168
Ⓒ	Auxiliary fuse box	_2
Ⓓ	Brake/clutch fluid reservoir <sup>1</sup>	168
Ⓔ	Battery	156
Ⓕ	Screen washer fluid reservoir (Power steering fluid reservoir <sup>3</sup> )	170
Ⓖ	Air cleaner	No maintenance necessary
Ⓗ	Engine oil dipstick <sup>1</sup>	167
Ⓘ	Power steering fluid reservoir (Screen washer fluid reservoir <sup>3</sup> )	170

1 For easy identification, filler caps and the engine oil dipstick are marked in colour.

2 The replacement of these fuses/relays requires specialised knowledge.

Please ask an expert to check them.

3 1.6 l Duratorq-TDCi engine only.

### 1.25/1.4/1.6 l Duratec

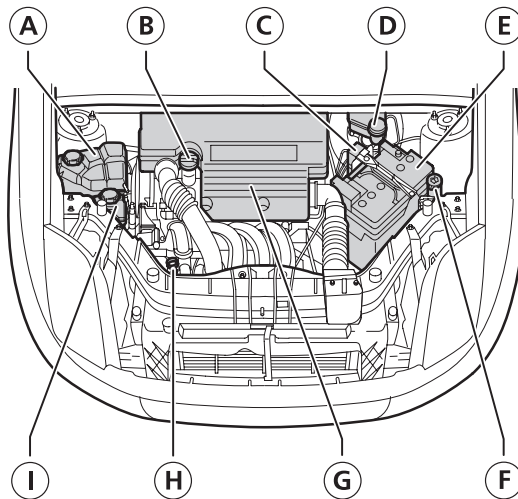

# Maintenance

## 1.4 | Duratorq-TDCi

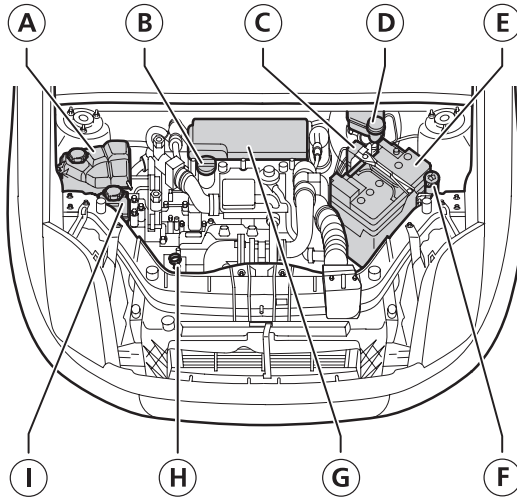

## 1.6 | Duratorq-TDCi

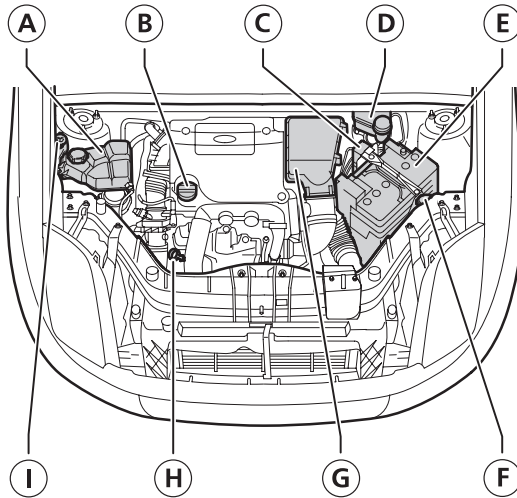

## Maintenance

### Engine oil dipstick

The oil consumption of new engines reaches the normal value only after approximately 5 000 km.

Make sure the vehicle is standing on level ground. Check the engine oil before starting the engine. If the engine was running, switch it off and wait some minutes for the engine oil to flow back into the sump before checking it. Pull out the dipstick, wipe it with a clean, non-fluffy cloth, re-insert it completely and pull it out once more.

If the level lies between the marks, there is no need to refill. Hot oil may exceed the MAX mark by some millimetres due to thermal expansion.

If it lies at the MIN mark refill using only engine oil meeting the Ford specification.

Top up to only the upper mark (MAX).

For further details, refer to section *Engine oil*, page 174 and table *Capacities*, page 174.

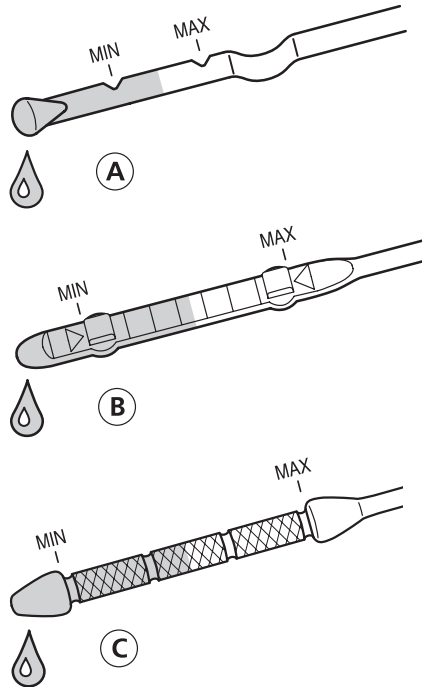

- Ⓐ 1.25/1.4/1.6 l Duratec engine
- Ⓑ 1.4 l Duratorq-TDCi engine
- Ⓒ 1.6 l Duratorq-TDCi engine



## Maintenance

### Oil pressure warning light

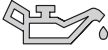

If the light stays on after starting or illuminates during a journey, stop immediately, switch off the engine and check the engine oil level.

Top up straight away if the level is low.



Do not resume the journey if the oil level is correct. Have the engine checked by an expert.

### Engine oil filler cap

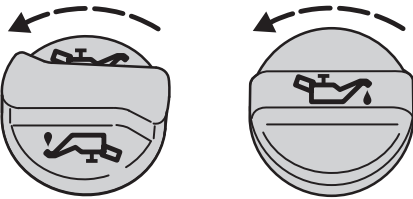

To open, turn in the direction of the arrow and pull. Do not open the cap while the engine is running.



Do not use oil additives or other engine treatments. They are unnecessary and could, under certain conditions, lead to engine damage which is not covered by Ford Warranty.

To close, turn the cap clockwise until it is fully tightened.

### Brake/clutch fluid reservoir



Do not allow this fluid to make contact with the skin or eyes. If this should happen rinse the affected areas immediately with plenty of water and contact your doctor.

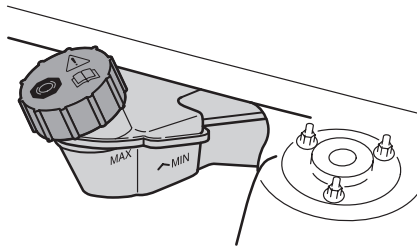

Brake and clutch fluid systems are supplied from the same reservoir.

The level of the fluid must lie between the **MIN** and **MAX** marks on the side of the reservoir.



If the level falls below the **MIN** mark, the Brake system warning light will illuminate. Refer to the section *Brake system warning*, page 98.

## Maintenance

### Cooling system reservoir

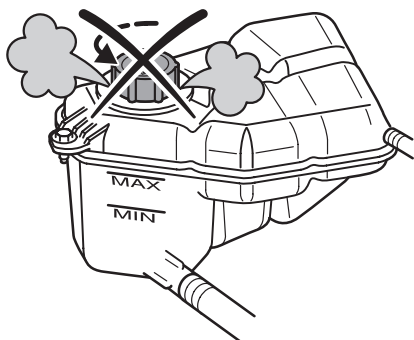

 To avoid scalding, never remove the cap from the coolant reservoir when the engine is hot. Do not restart the engine until the problem has been eliminated.

The coolant level is visible through the translucent reservoir.

The coolant level should be between the **MIN** and the **MAX** mark when the engine is cold. Hot coolant expands and may, therefore, extend beyond the **MAX** mark.

The coolant should be added when the engine is cold. If coolant has to be added when the engine is hot, first wait 10 minutes for the engine to cool.

Unscrew the cap slowly. Any pressure will escape while you are turning the cap. Fully remove the cap.

 Take great care when adding coolant. Avoid spillage on any part of the engine.

When the vehicle is new, the cooling system is filled with coolant which offers anti-freeze protection down to approximately  $-25^{\circ}\text{C}$ .

Add only coolant that meets the Ford Specification. For further details, refer to section *Vehicle fluids*, page 174.

### **Engine coolant temperature warning**

HIGH ENGINE  
TEMPERATURE

On vehicles with a Message Centre, this message will appear in the display and the display warning light illuminates red.

Refer also to the section *Engine coolant temperature gauge*, page 19.

### **Engine coolant**

 Do not allow this fluid to make contact with the skin or eyes. If this should happen rinse the affected areas immediately with plenty of water and contact your doctor.

## Maintenance

### Checking power steering fluid level

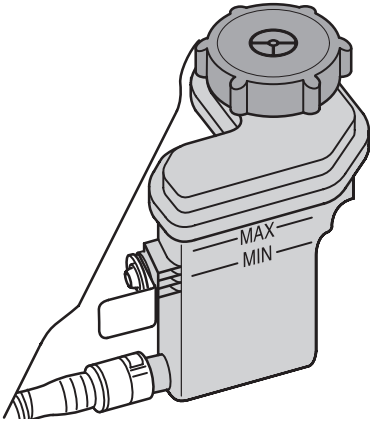

The fluid level should come up to the **MAX** mark when the engine is cold.

If it drops below the **MIN** mark, top up with the specified fluid. For further details, refer to section *Vehicle fluids*, page 174.

#### **1.6 I Duratorq-TDCi engine**

No fluid level checks are necessary.

### Screen washer systems

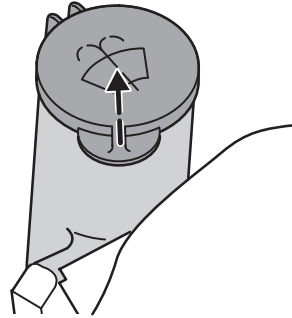

Front and rear washer systems are supplied from the same reservoir.

Replace the cap securely after topping up.

### Adjusting screen washer jets

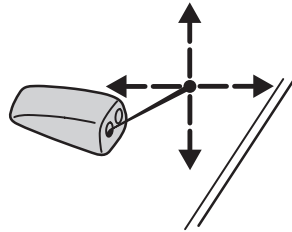

The eye ball jets can be adjusted precisely using a pin.

The washer jet for the rear screen is located on the high mounted central brake light.

## Maintenance

### Checking wiper blades

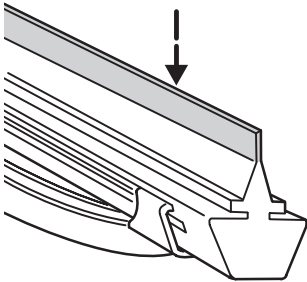

Check the wiper blades on your vehicle for roughness by running the tip of your fingers over the edge of the blade. Clean the wiper blade lips with water applied with a soft sponge.

### Renewing wiper blades

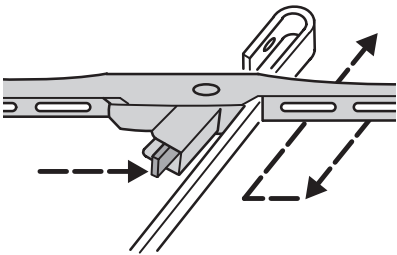

Lift the wiper arm and position the wiper blade at a right angle to the wiper arm. To remove, press the retaining clip in the direction of the arrow, disengage the wiper blade and pull it off the arm in the opposite direction.

### TYRE INFORMATION



To make sure the front and rear tyres wear evenly and last longer, it is recommended that you swap the tyres from front to rear and vice versa at regular intervals of 5 000 to 10 000 km as shown in the graphic.

Depending on driving style and surface conditions the most appropriate interval can vary.

### For your safety

If you have to mount a kerb, do so slowly and, if possible, approach it with the wheels at right-angles to the kerb. Avoid steep and sharp edged obstacles. Do not scrub the tyre sidewalls when parking.

Regularly examine the tyre surface for cuts, foreign bodies and uneven wear. An uneven tread wear pattern could indicate faulty wheel alignment.

Refer to page 178 for permissible snow chains.

# Capacities and specifications

## IDENTIFICATION NUMBERS

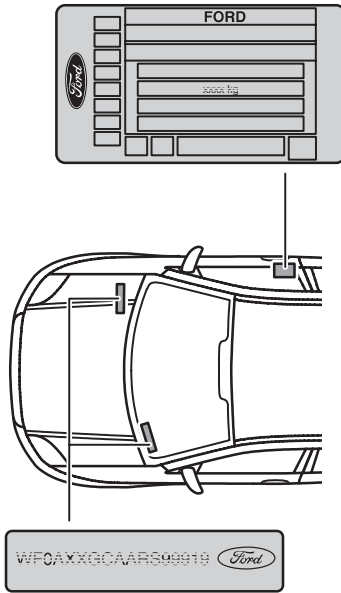

### Vehicle identification plate

The vehicle identification plate is located on the lower section of the right-hand front door pillar.

### Vehicle identification number

The number is located in the engine compartment. It is additionally stamped onto a tag on the left-hand side of the instrument panel.

## Engine number

The engine number is located on the engine block (seen in the direction of travel):

- All engines – near gearbox on front left-hand side facing the radiator.

## FUEL

Use only high quality fuel without any supplemental additives or other engine treatments.

### Vehicles with a petrol engine

Use **unleaded** petrol according to specification EN 228 or equivalent with **minimum 95 octane**. Leaded fuel or fuel/additives containing other metallic compounds (e.g. manganese-based) may damage the emission system.

### Vehicles with a diesel engine

Use diesel fuel according to specification EN 590 or equivalent.

Do not mix it with any oil, petrol or other liquids.

Diesel fuels which contain a mix of up to 5 % RME (bio diesel) are acceptable.

Prolonged use of supplemental additives to prevent fuel waxing is not recommended. Do not add kerosene, paraffin or petrol to diesel fuels.

## Capacities and specifications

Fuel consumption according to EC Directive 80/1268/EEC					
Tyre size	Axle ratio	Fuel consumption – litres/100 km			CO <sub>2</sub> emissions (g/km)
		Urban environment	Non-urban environment	Total	
<b>1.25 I Duratec (Stage III/Stage IV)</b>					
All	4.25	8.6	5.1	6.4	152
<b>1.4 I Duratec (Stage III/Stage IV) Manual transmission</b>					
All	4.25	8.5	5.3	6.5	154
<b>1.4 I Duratec (Stage IV) Durashift EST transmission</b>					
All	4.25	8.0	5.2	6.2	148
<b>1.6 I Duratec (Stage III/Stage IV) Manual transmission</b>					
All	4.25	8.9	5.3	6.6	157
<b>1.6 I Duratec (Stage IV) Automatic transmission</b>					
All	- <sup>1</sup>	10.3	6.1	7.6	181
<b>1.4 I Duratorq-TDCi (Stage III) Manual transmission</b>					
All	3.61	5.3	3.9	4.4	116
<b>1.4 I Duratorq-TDCi (Stage IV) Manual transmission</b>					
All	3.61	5.7	4.0	4.6	122
<b>1.4 I Duratorq-TDCi (Stage III) Durashift EST transmission</b>					
All	3.37	5.1	3.9	4.3	114
<b>1.6 I Duratorq-TDCi (Stage III/Stage IV) Manual transmission</b>					
All	3.37	5.5	4.0	4.5	119

<sup>1</sup> Data not available at the time of printing.

# Capacities and specifications

## ENGINE OIL

### Engine oil change

Use Ford/Motorcraft **Formula E SAE 5W-30** engine oil.

Alternative engine oils with the viscosity **SAE 5W-30** meeting the requirements of Ford Specification **WSS-M2C913-B** may also be used.

For petrol engines, engine oil meeting the Ford specification **WSS-M2C913-A** may also be used.

### Engine oil top-up

If you are unable to find an oil that meets this specification, you must use an oil of the viscosity **SAE 5W-30**, SAE 5W-40 or SAE 10W-40 according to ambient temperatures, meeting the requirements of either **ACEA A1/B1** or ACEA A3/B3 specifications. Use of these oils may result in longer cranking periods, reduced engine performance, reduced fuel economy and increased emission levels.

## VEHICLE FLUIDS

Part	Recommended fluid	Specification
Power assisted steering	Ford Power Steering Fluid	WSA-M2C 195-A
Coolant	Motorcraft SuperPlus Antifreeze	WSS-M97 B44-D

Capacities (litres)					
Engine	1.25 l Duratec	1.4 l Duratec	1.6 l Duratec	1.4 l Duratorq- TDCi	1.6 l Duratorq- TDCi
Engine oil – with filter	3.75 <sup>1</sup> /3.80 <sup>2</sup>	3.75 <sup>1</sup> /3.80 <sup>2</sup>	4.10 <sup>2</sup> /4.25 <sup>3</sup>	3.80	3.85
– without filter	3.50	3.50	3.75	3.40	3.45
Power assisted steering	MAX mark				
Cooling system including heating	5.0			5.5	6.0
Screen washer system	2.5				
Fuel tank	45			43	

1 With engine oil filter EFL 500

2 With engine oil filter EFL 10

3 With engine oil filter EFL 600

## Capacities and specifications

### VEHICLE WEIGHT

<b>Vehicle weight (kg)</b>	
<b>1.25 I Duratec</b>	
EC base kerb weight	1157
Maximum payload	448
Permissible gross weight	1605
Permissible roof rack weight	25
<b>1.4 I Duratec</b>	
EC base kerb weight	1156
Maximum payload	449
Permissible gross weight	1605
Permissible roof rack weight	25
<b>1.4 I Duratec Durashift EST transmission</b>	
EC base kerb weight	1162
Maximum payload	443
Permissible gross weight	1605
Permissible roof rack weight	25
<b>1.6 I Duratec without ESP</b>	
EC base kerb weight	1159
Maximum payload	446
Permissible gross weight	1605
Permissible roof rack weight	25
<b>1.6 I Duratec with ESP</b>	
EC base kerb weight	1159
Maximum payload	441
Permissible gross weight	1600
Permissible roof rack weight	50
<b>1.6 I Duratec Automatic transmission</b>	
EC base kerb weight	1164
Maximum payload	466
Permissible gross weight	1630
Permissible roof rack weight	25



## Capacities and specifications

<b>Vehicle weight (kg)</b>	
<b>1.4 I Duratorq-TDCi without ESP</b>	
EC base kerb weight	1157
Maximum payload	483
Permissible gross weight	1640
Permissible roof rack weight	25
<b>1.4 I Duratorq-TDCi with ESP</b>	
EC base kerb weight	1157
Maximum payload	478
Permissible gross weight	1635
Permissible roof rack weight	50
<b>1.4 I Duratorq-TDCi Durashift EST transmission</b>	
EC base kerb weight	1162
Maximum payload	478
Permissible gross weight	1640
Permissible roof rack weight	25
<b>1.6 I Duratorq-TDCi without ESP</b>	
EC base kerb weight	1165
Maximum payload	510
Permissible gross weight	1675
Permissible roof rack weight	25
<b>1.6 I Duratorq-TDCi with ESP</b>	
EC base kerb weight	1165
Maximum payload	505
Permissible gross weight	1670
Permissible roof rack weight	50

## Capacities and specifications

### TYRE DATA

#### Tyre pressure

The pressure for your spare tyre should be set to the highest value given for your vehicle/tyre size combination.

**Note:** If the spare wheel rim or tyre size differs from the other wheels fitted, see also section *Spare wheel*, page 151 onwards.

When using winter tyres, the tyre pressures recommended by the tyre manufacturer should be adhered to.

Standard tyre pressures up to 160 km/h (cold tyres)					
Model	Tyre size <sup>1</sup>	bar			
		Normal load up to 3 persons		Full load more than 3 persons	
		Front	Rear	Front	Rear
All	175/65 R 14 <sup>2</sup>	3.0	3.0	3.0	3.0
	185/60 R 14 <sup>3</sup>	2.4	2.2	2.5	2.8
	195/60 R 15	2.4	2.2	2.5	2.8
	195/55 R 16	2.4	2.2	2.5	2.8
	T125/80 R 14 <sup>2</sup>	4.2	4.2	4.2	4.2

1 Summer tyres with various speed rating, depending on engine performance.

2 Spare wheel/Temporary spare wheel, maximum speed 80 km/h.

3 Winter tyres.

#### Comfort tyre pressures

Driving at comfort tyre pressures will improve ride comfort, however it will alter the driving characteristics and fuel consumption of the vehicle.

For optimum dynamic performance standard pressure settings are recommended.



If the vehicle is used with a roof load, or is fully laden, the tyres **must** be set to standard tyre pressure setting.

Comfort tyre pressures up to 160 km/h (cold tyres)					
Model	Tyre size	bar			
		Normal load up to 3 persons		Full load more than 3 persons	
		Front	Rear	Front	Rear
All	185/60 R 14 <sup>3</sup>	2.0	1.8	2.5	2.8
	195/60 R 15	2.0	1.8	2.5	2.8
	195/55 R 16	2.0	1.8	2.5	2.8

3 Winter tyres.

## Capacities and specifications

Tyre pressures for continuous road speed over 160 km/h (cold tyres)					
Model	Tyre size <sup>1</sup>	bar			
		Normal load up to 3 persons		Full load more than 3 persons	
		Front	Rear	Front	Rear
All	195/60 R 15	2.4	2.2	2.5	2.8
	195/55 R 16	2.4	2.2	2.5	2.8

<sup>1</sup> Summer tyres with various speed rating, depending on engine performance.

### Snow chains

Use only the recommended small link snow chains on the driving wheels (front).

Snow chains must only be fitted to 14" x 5.5" J (47.5 offset) steel wheels with 185/60 R 14 winter tyres.

Do not exceed 50 km/h. Remove the chains immediately on snow-free roads.

The ABS will continue to function normally.

Vehicles with Electronic Stability Program (ESP) may exhibit some unusual driving characteristics which can be avoided by switching the system off. Refer to the section *Electronic Stability Program (ESP)*, page 101.

In order to avoid damaging full-diameter wheel covers, they should be removed before driving with snow chains.

## Capacities and specifications

### DIMENSIONS

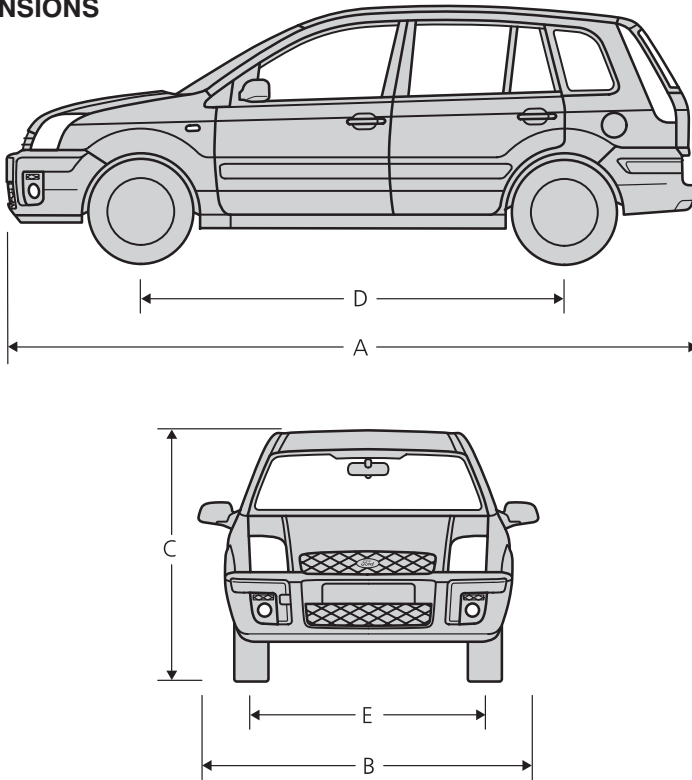

Dimensions		mm
A = Maximum length		4013
B = Overall width (including exterior mirrors)		1950/1963 <sup>1</sup>
C = Overall height (EC kerb weight)		1512-1543
D = Wheelbase		2486
E = Track	front	1477-1487
	rear	1435-1445

<sup>1</sup> Vehicles with electrically operated outside mirrors

## Capacities and specifications

### ATTACHMENT POINTS FOR TOWING EQUIPMENT

 The installation of towing equipment should only be performed by an expert.

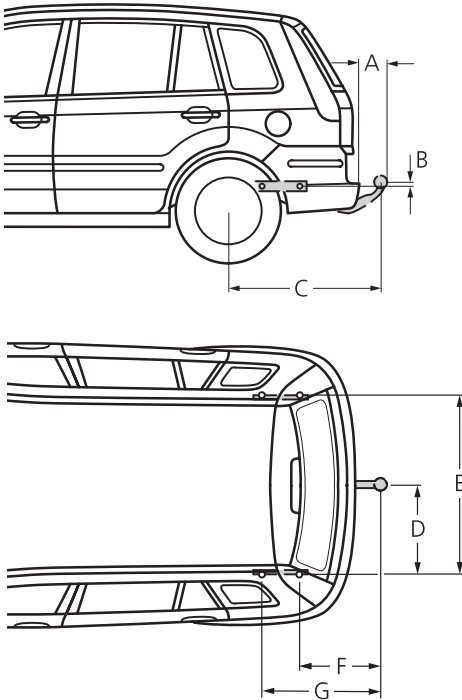

Distances	mm <sup>1</sup>
A = Bumper – end of towball	133
B = Attachment point – centre of towball	12
C = Wheel centre – centre of towball	869
D = Centre of towball – side member	493
E = Inner side of side member	986
F = Centre of towball – centre 1. attachment point	436
G = Centre of towball – centre 2. attachment point	721





<sup>1</sup> All measurements refer to towing equipment officially released by Ford.

## Capacities and specifications

### RADIO FREQUENCY REMOTE CONTROL

If the type approval of your remote control is inspected, refer to the table below.

It is recommended that you use the remote control only in the countries listed.

Type approval of the remote control	
Country	Official test number
(A) (B) (D) (DK) (E) (F) (FIN) (GB) (GR) (H) (I) (IRL) (IS) (L) (N) (NL) (P) (S)	CE 0499 0 <sup>1</sup>
(AUS) (BR) (GBZ) (M) (TR)	<b>SIEMENS</b> 433,92 MHz 5WK4 725/8686/8071
(CH)	BAKOM 97.0946.K.P.
(CY)	MCW 129/95 23/1997
(CZ)	 ČTÚ 1999 2 R 712 
(IL)	272/3-1998
(NZ)	
(PL)	542/98
(RC)	 電波 88LP0012
(SK)	 TÚ R 119 SR 1999 2
(ZA)	Ref.No.: 3K43D/3R1B9/SPLS-RX9/98

<sup>1</sup> Hereby, Siemens, declares that this remote control is in compliance with the essential requirements and other relevant provisions of Directive 1999/5/EC.

## Capacities and specifications

### ENGINE IMMOBILISATION SYSTEM

If the type approval of your engine immobilisation system is inspected, refer to the table below.

Type approval of the engine immobilisation system	
Country	Official test number
(A) (B) (CH) (HR) (D) (DK) (E) (F) (FIN) (GB) (GR) (H) (I) (IRL) (IS) (L) (N) (NL) (P) (S) (SLO)	<b>CE 0682 0</b>
(AUS)	No label required
(BR)	_ 1
(CDN)	3043 104475A
(CY)	M.C.W. 129/95 /(11)
(CZ)	
(HK)	<div style="border: 1px solid black; padding: 5px;"> <p style="font-size: small;">This device complies with the Telecommunication (Low Power Devices) (Exemption From Licensing) Order 此產品符合電訊(小功率器件) 豁免牌照 令</p> <p>Certificate No.: <b>LP402055</b> 證書號碼:</p> <p style="font-size: x-small;">Office of the Telecommunications Authority 電訊管理局</p> </div>
(IL)	_ 1
(J)	No type approval necessary.
(M)	WT/122/98 II
(NZ)	ENG 3/2/RFS29
(PL)	M.Ł. S.H. Nr. 003/2002

<sup>1</sup> Data not available at the time of printing.

## Capacities and specifications

Type approval of the engine immobilisation system	
Country	Official test number
(RC)	(電波) 電波 91LP0034
(SGP)	LPREQ-0259-2002
(SK)	171
(TR)	B.61.TK.0.22.00.00/4940-2632
(USA)	FCC ID: NT8-15607-PAT3XCVR



# Index

## A

- ABS. *See* Brakes
- Activity console. *See* Storage areas
- Air conditioning. *See* Heating, ventilation and air conditioning
- Airbag ..... 87-92
  - Airbag deactivation ..... 91-92
  - Airbag deactivation light ... 91-92
  - Airbag warning light ..... 91
  - Curtain airbags ..... 90
  - Front airbags ..... 88
  - Passenger airbag deactivation . 91
  - Side airbags ..... 89
- Anti-lock braking system (ABS).  
*See* Brakes
- Anti-theft alarm system ..... 76
  - Switch off the alarm ..... 76
- Ashtray, Front ashtray ..... 63
- Audio remote control. *See* Audio systems
- Audio systems
  - Audio remote control ..... 58
  - Radio display ..... 33

## A

- Automatic transmission ... 107-114
  - Cold mode ..... 112
  - Drive modes ..... 111-114
  - Emergency park position release ..... 111
  - Gear display ..... 107
  - Kickdown ..... 112
  - Moving off ..... 110
  - Overdrive ..... 109
  - Parking ..... 108
  - Release button ..... 107
  - Selector lever lock ..... 107, 111
  - Selector lever positions .. 107-109
  - Starting the vehicle ..... 105
  - Stopping ..... 110
  - Towing ..... 160
  - Transmission/Engine systems fault warning light ..... 113-114
  - Warning signal, audible ..... 108
- Auxiliary heater ..... 45

## Index

### B

- Battery . . . . . 156
  - Booster battery . . . . . 157-158
  - Disconnected battery . . . . . 156
  - Ignition warning light . . . . . 156
  - Maintenance . . . . . 156
  - Remote control,  
battery replacing . . . . . 72
- Body paintwork preservation . . 162
- Bonnet . . . . . 164
- Brakes . . . . . 98-100
  - ABS warning light . . . . . 99
  - Anti-lock braking system  
(ABS) . . . . . 99
  - Brake fluid reservoir . . . . . 168
  - Brake system warning light 98-99
  - Disc brakes . . . . . 98
  - Dual circuit braking system . . . 98
  - Emergency Brake Assist . . . . . 100
  - Handbrake . . . . . 100
  - Hazards on heavy breaking . . . 100

### C

- Capacities and  
specifications . . . . . 172-183
- Central door locking. *See* Locking  
system
- Children
  - Child restraints . . . . . 93-97
  - Childproof safety locks . . . . . 66
  - Mass group categories . . . . . 94
  - Placement of child seats . . . 94-96
- Cigar lighter . . . . . 63
- Clock, digital. *See* Digital clock
- Clutch fluid,  
Clutch fluid reservoir . . . . . 168

### C

- Cooling system
  - Antifreeze . . . . . 169
  - Coolant . . . . . 169
  - Coolant capacity . . . . . 174
  - Temperature gauge . . . . . 19

### D

- Date . . . . . 9
- Digital clock . . . . . 9, 20
- Dimensions . . . . . 179-180
- Driving,  
Driving with a roof load . . . . . 136
- Driving with a  
catalytic converter . . . . . 126
- Durashift EST . . . . . 115-121
  - Downshift (Kickdown) . . . . . 120
- Driving on inclines . . . . . 121
- Gear display . . . . . 116
- Parking . . . . . 121
- Starting the engine . . . . . 105
- Stopping . . . . . 120
- Towing . . . . . 159
- Transmission/Engine systems fault  
warning light . . . . . 121, 122
- Warning signal, audible . . . . . 120

# Index

## E

- Electronic Stability Program (ESP) . . . . . 101-102
- Engine compartment . . . . . 165-166
- Engine oil . . . . . 167-168
  - Capacities . . . . . 174
  - Engine oil dipstick . . . . . 167
  - Engine oil filler cap . . . . . 168
  - Oil pressure warning light . . . . . 168
  - Oil specifications . . . . . 174
- Engine speed limiter . . . . . 103
- Engines
  - Bonnet . . . . . 164
  - Compartment . . . . . 165-166
  - Coolant . . . . . 169
  - Diesel engine, starting . . . . . 104
  - Diesel engine, switching off . . 104
  - Diesel low fuel safety mode . . 124
  - Disconnected battery . . . . . 156
  - Engine immobilisation system . . . . . 73-75
  - Engine immobilisation system, type approval . . . 182-183
  - Engine number . . . . . 172
  - Engine warning light . . . . . 123
  - Limited operation strategy programme . . . . . 138
  - Oil . . . . . 167-168, 174
  - Petrol engine, flooded . . . . . 103
  - Petrol engine, starting . . . . . 103
  - Running in . . . . . 13
- Environment protection . . . . . 13

## F

- Filling capacities . . . . . 174
- First aid kit . . . . . 138
- Fog lights. *See* Lights
- Front and rear screen, heated . . 45
- Front screen, heated . . . . . 45
- Fuel . . . . . 172
  - Diesel fuel . . . . . 172
  - Diesel low fuel safety mode . . 124
  - Filling up . . . . . 125
  - Fuel consumption . . . . . 173
  - Fuel gauge . . . . . 19
  - Incorrect fuel . . . . . 125
  - Low fuel level warning light . . 124
  - Petrol fuel . . . . . 172
  - Refuelling . . . . . 124
  - Specifications . . . . . 172
  - Tank capacity . . . . . 174
  - Unleaded . . . . . 172
- Fuel filler flap . . . . . 125
- Fuel injection system shut-off switch . . . . . 139
- Fuses . . . . . 140-143

## G

- Gauges . . . . . 19-21
- Glove compartment. *See* Storage areas

## Index

### H

- Handbrake . . . . . 100
- Hazard flasher switch . . . . . 138
- Hazards on heavy braking . . . . . 33
  - See also* Brakes
- Head restraints. *See* Seats
- Heating, ventilation and air conditioning . . . . . 36-44
  - Active carbon filter . . . . . 36
  - Adjusting the temperature . . . . . 38
  - Air conditioning . . . . . 37, 40-41
  - Air conditioning, maintenance . . . . . 163
  - Air distribution . . . . . 38, 43
  - Blower . . . . . 38
  - Controls . . . . . 38
  - Defrosting the windows . . . . . 39, 43
  - Electronic automatic temperature control . . . . . 41-43
  - Fresh air filter . . . . . 36
  - General notes . . . . . 37
  - Rapid cooling . . . . . 40
  - Recirculated air . . . . . 36, 40
  - Vents . . . . . 36
- Horn . . . . . 54

### I

- Identification numbers . . . . . 172
- Ignition switch . . . . . 102
- Immobilisation system . . . . . 73-75
  - Coded keys . . . . . 73
- Indicator lights. *See* Warning and indicator lights
- Information messages . . . . . 26-29
- Instrument cluster . . . . . 16-21
- Instrument panel . . . . . 14-15
- Interior lights. *See* Lights

### J

- Jack . . . . . 153
- Jacking points . . . . . 153-154
- Jump starting . . . . . 157-158

### K

- Keys. *See* Locking system

# Index

## L

### Lights

- Autolamps . . . . . 46-47
- Bulb replacement . . . . . 144-150
- Dipped beam . . . . . 46, 52
- Direction indicator lever . . . . . 51
- Direction indicator light . . . . . 52
- Exterior lights, audible warning signal . . . . . 46
- Front fog lights . . . . . 47-48
- Hazards on heavy braking . . . 33, 51
- Headlight flasher . . . . . 52
- Headlight levelling control . . . . 50
- Headlights . . . . . 46
- Home safe lights . . . . . 48-49
- Interior lights . . . . . 53
- Lane change indicators . . . . 33, 51
- Light switch . . . . . 46
- Main beam . . . . . 52
- Main beam indicator light . . . . . 52
- Multifunction lever . . . . . 51
- Reading lights . . . . . 53
- Rear fog light . . . . . 48
- Side lights . . . . . 46
- Welcome lights . . . . . 49

## L

### Locking system

- Central door locking . . . . . 68-72
- Childproof safety locks . . . . . 66
- Doors open warning light. *See* Warning and indicator lights
- Double locking . . . . . 68-71
- Ignition switch . . . . . 102
- Keys . . . . . 64-65
- Keys, coded for immobilisation system . . . . . 73
- Locking the vehicle . . . . . 70-71
- Locks . . . . . 65-67
- Luggage compartment . . . . . 66-67
- Opening the bonnet . . . . . 164
- Remote control . . . . . 64-65
- Remote control, battery replacing . . . . . 72
- Remote control, programming . . . . . 71-72
- Remote control, type approval . . . . . 181
- Reprogramming the unlocking function . . . . . 33
- Steering lock . . . . . 102
- Unlocking the vehicle . . . . . 69

### Luggage compartment

- Closing the tailgate . . . . . 67
- Increasing load floor . . . . . 81-82
- Luggage cover . . . . . 127
- Luggage net . . . . . 128
- Opening the tailgate . . . . 66-67, 69
- Transporting luggage . . . . 126-127
- Warning light, luggage compartment . . . . . 67

## M

- Maintenance chart . . . . . 163
- Manual transmission . . . . . 106
- Map pockets. *See* Storage areas
- Message Centre . . . . . 20-21, 22-35
  - Average fuel consumption . . . . . 25
  - Average speed . . . . . 25
  - Chime deactivation . . . . . 34
  - Controls . . . . . 22
  - Display warning light . . . . . 26-29
  - Distance to empty . . . . . 25
  - Fuel economy . . . . . 25
  - Main menu overview . . . . . 24
  - Measure units . . . . . 35
  - Odometer . . . . . 25
  - Outside temperature . . . . . 25
  - Setting the language . . . . . 34-35
  - Settings menu . . . . . 31-35
  - Settings menu overview . . . . . 32
  - Time setting . . . . . 30
  - Tripmeter . . . . . 25
  - Warning/information messages . . . . . 26-29
- Mirrors
  - Interior rear-view mirror . . . . . 59
  - Outside rear-view mirrors, electrically operated . . . . . 60
  - Outside rear-view mirrors, convex . . . . . 59
  - Outside rear-view mirrors, folding . . . . . 59, 60
  - Outside rear-view mirrors, heated . . . . . 60
  - Outside rear-view mirrors, manually . . . . . 59

## M

- Multifunction display . . . . . 20-21
- Multifunction lever. *See* Lights

## O

- Odometer . . . . . 21, 25
- Oil types . . . . . 174

## P

- Paint chip repair . . . . . 162
- Parking . . . . . 126
  - Automatic transmission . . . . . 108
  - Durashift EST . . . . . 121
  - Handbrake . . . . . 100
  - Parking on a hill . . . . . 100
  - Ultrasonic park distance sensor . . . . . 137
- Power point . . . . . 63
- Power windows. *See* Power windows
- Preface . . . . . 12

## R

- Radio frequency remote control, type approval . . . . . 181
- Rear screen, heated . . . . . 45
- Refill capacities . . . . . 174
- Reverse gear wipe. *See* Screen washing/wiping
- Roof rack . . . . . 136

# Index

## S

- Screen washing/wiping
  - Autowipers . . . . . 55-56
  - Front screen wiping . . . . . 55-56
  - Intermittent wipe interval . . . . . 55
  - Rear screen washing/wiping . . . . . 57
  - Reverse gear wipe . . . . . 57
  - Washer . . . . . 57
  - Washer fluid capacity . . . . . 174
  - Washer fluid reservoir . . . . . 170
  - Washer jets . . . . . 170
  - Wiper blades . . . . . 171
  - Wiper lever . . . . . 55-57
- Seat belts . . . . . 82-86
  - Adjusting the height . . . . . 83
  - Care of seat belts . . . . . 86
  - Pregnant women . . . . . 84
  - Seat belt pretensioner . . . . . 85
  - Seat belt pretensioner warning light . . . . . 91
- Seats . . . . . 77-82
  - Armrest . . . . . 78
  - Child restraints . . . . . 93-97
  - Correct position . . . . . 77
  - Fold flat front passenger seat . . . . . 79
  - Folding the rear seatback forwards . . . . . 81
  - Folding the seat cushion and seatback forwards . . . . . 4, 82
  - Head restraints . . . . . 80
  - Heated front seats . . . . . 79-80
  - Mass group categories . . . . . 94
  - Seat covers . . . . . 77, 90

## S

- Servicing . . . . . 163-171
- Socket/cigar lighter . . . . . 63
- Speedometer . . . . . 19
- Starting the engine . . . . . 103-104
- Starting, general points . . . . . 103
- Steering
  - Adjusting the steering wheel . . . . . 54
  - Power steering fluid level . . . . . 170
  - Steering lock . . . . . 102
- Storage areas
  - Activity console . . . . . 131-132
  - Card holder . . . . . 2, 129
  - Coin holder . . . . . 2, 129, 130
  - Front storage compartment . . . . . 2, 128
  - Glove compartment . . . . . 2, 129
  - Map pockets . . . . . 4, 130
  - Pencil clip . . . . . 2, 129
  - Storage area passenger side . . . . . 128
  - Storage compartment . . . . . 2, 128
  - Storage pockets . . . . . 3, 130
  - Under-seat storage . . . . . 3, 129
- Storage pockets. *See* Storage areas
- Sun visors . . . . . 62
- Sunroof . . . . . 62

## T

- Tachometer . . . . . 19
- Towing
  - Attachment points . . . . . 180
  - Pushing/towing . . . . . 158-160
  - Starting by towing or pushing 160
  - Towing eye . . . . . 153, 158-159
- Trailer
  - Tow bar . . . . . 133-136
  - Trailer coupling, removable . . . . . 133-136
- Trailer towing . . . . . 133
  - Steep gradients . . . . . 133
- Tripmeter . . . . . 21, 25
- Tyres and wheels
  - Changing a wheel . . . . . 151-156
  - Directional tyres . . . . . 151
  - Fitting a wheel . . . . . 155-156
  - Jacking up . . . . . 153-155
  - Removing a wheel . . . . . 154-155
  - Snow chains . . . . . 178
  - Spare wheel . . . . . 151-152
  - Tyre data . . . . . 177-178
  - Tyre information . . . . . 171
  - Tyre pressure . . . . . 177-178

## U

- Under-seat storage. *See* Storage areas

## V

- Vehicle care . . . . . 161
- Vehicle fluids . . . . . 174
  - Capacities . . . . . 174
  - Specification . . . . . 174
- Vehicle identification number . . 172
- Vehicle identification plate . . . 172
- Vehicle weight . . . . . 175-176
- Ventilation. *See* Heating, ventilation and air conditioning



# Index

## W

Warning and indicator lights  
ABS warning light ..... 99  
Airbag deactivation light ... 91-92  
Airbag/seat belt pretensioner  
warning light ..... 91  
Brake system  
warning light ..... 98, 99, 168  
Direction indicator light ..... 52  
Doors open warning light ..... 67  
Electronic Stability Program  
(ESP) indicator light .... 101-102  
Engine warning light ..... 123  
Front fog light  
indicator light ..... 47-48  
Frost warning ..... 124  
Glow plug indicator light ..... 104  
Ignition warning light ..... 156  
Low fuel level warning light .. 124  
Main beam indicator light ..... 52  
Oil pressure warning light .... 168  
Overdrive indicator light ..... 109  
Power steering ..... 123  
Rear fog light indicator light ... 48  
Transmission/Engine systems fault  
warning light ... 113-114, 121, 122

## W

Warning lights. *See* Warning and  
indicator lights  
Warning messages ..... 26-29  
Warning signal, audible  
Automatic transmission ..... 108  
Chime deactivation ..... 34  
Durashift EST ..... 120  
Exterior lights ..... 46  
Low fuel level ..... 124  
Message Centre, confirmation  
chime ..... 22  
Ultrasonic park  
distance sensor ..... 137  
Warning symbols ..... 13  
Warning triangle ..... 138  
Warranty ..... 162  
Washing the vehicle ..... 161  
Weights ..... 175-176  
Wheels. *See* Tyres and wheels  
Wiper lever. *See* Screen  
washing/wiping